

SCHULTE®

FLX15/FLX10

Flex-Arm

Published 04-06

S/NA10100003306- A10100152509 inclusive
S/NA10200002306- A10200051405 inclusive

Part No. A101-010C

OPERATOR'S MANUAL



This Operator's Manual is an integral part of the safe operation of this machine and must be maintained with the unit at all times. **READ, UNDERSTAND, and FOLLOW** the Safety and Operation Instructions contained in this manual before operating the equipment.

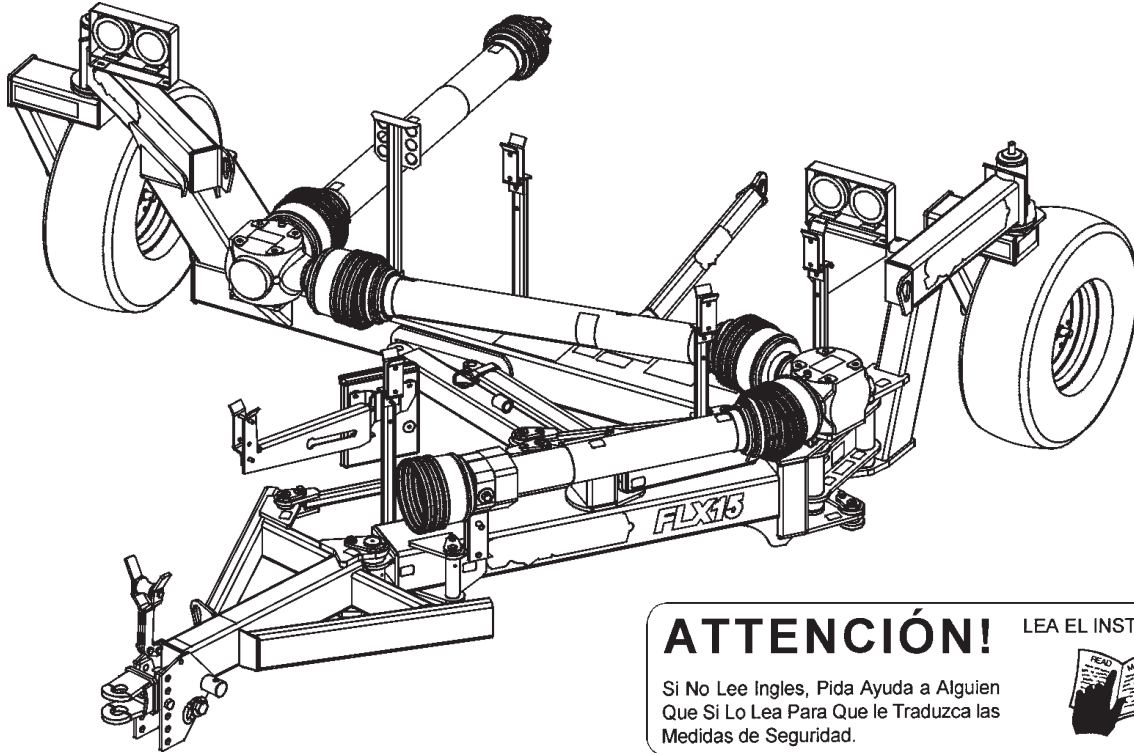

ATENCIÓN!

LEA EL INSTRUCTIVO

Si No Lee Ingles, Pida Ayuda a Alguien
Que Si Lo Lea Para Que le Traduzca las
Medidas de Seguridad.



Schulte Industries Ltd.

P.O. Box 70
Englefeld Saskatchewan Canada S0K 1N0
Tel. (306)287-3715
Fax. (306)287-3355
Parts Fax. (306)287-4066
Email: info@schulte.ca



ISO 9001:2000



© 2006 Alamo Group Inc.

TO THE OWNER/OPERATOR/DEALER

All implements with moving parts are potentially hazardous. There is no substitute for a cautious, safe-minded operator who recognizes the potential hazards and follows reasonable safety practices. The manufacturer has designed this implement to be used with all its safety equipment properly attached to minimize the chance of accidents.

BEFORE YOU START!!

Read the safety messages on the implement and shown in your manual.
Observe the rules of safety and common sense!



DANGER

FAILING TO FOLLOW SAFETY MESSAGES AND OPERATING INSTRUCTIONS CAN CAUSE SERIOUS BODILY INJURY OR EVEN DEATH TO OPERATOR AND OTHERS IN THE AREA.

1.

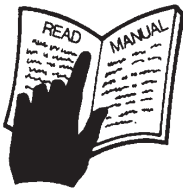

2. NO RIDERS. NO CHILDREN OPERATORS.



3. USE SAFETY SHOES, HARD HAT, SAFETY GLASSES, SEAT BELTS, & ROPS.



4. BLOCK UP SECURELY BEFORE WORKING UNDER.



1. Study and understand Operator's Manuals, Safety Signs, and Instructional Decals for tractor and implement to prevent misuse, abuse and accidents.
 - Learn how to stop engine suddenly in an emergency. Be alert for passersby and especially children.
2. Allow no children on or near implement or tractor. Allow no riders on tractor or implement. Falling off may cause serious injury or death from being run over by tractor or cutter or contact with rotating blades.
3. Operate only with tractor having Roll-Over Protective Structure (ROPS) and with seatbelt fastened securely and snugly to prevent injury and possible death from falling off or tractor overturn. Personal Protective Equipment such as Hard Hat, Safety Glasses, Safety shoes, and Ear Plugs are recommended.
4. Block up or support raised machine and all lifted components securely before putting hands or feet under or working underneath any lifted components to prevent crushing injury or death from sudden dropping or inadvertent operation of controls. Make certain area is clear before lowering or folding.
5. Before transporting, put Lift Lever in detent or full-lift position. Secure the implement for transport by installing Cylinder Stops or Transport Pin on pull-type implement center axle and Wing Transport Locks on folding implements.
 - Attach Safety Chain to cutter and towing unit securely. See Operator's Manual.
6. Make certain that SMV sign, Warning Lights, and Reflectors are clearly visible. Follow local traffic codes.
7. Never operate with Cutting Head raised if passersby, bystanders, or traffic are in the area to reduce possibility of injury or death from objects thrown by Blades under Guards or cutter structure.
8. Before dismounting, secure implement in transport position or lower to ground.
 - Put tractor in park or set brake, disengage PTO, stop engine, and remove key, and wait until noise of rotation has ceased to prevent entanglement in rotating parts which can cause injury or death.
 - Never mount or dismount a moving vehicle. Crushing from runover may cause injury or death.

5. TRANSPORT SAFELY, LOCK UP.

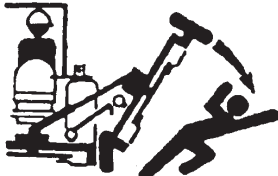

6. USE SMV, LIGHTS, & REFLECTORS.

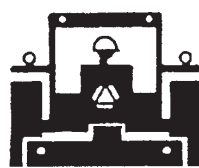

7. DO NOT OPERATE WITH CUTTER OR WING RAISED.



8. DO NOT MOUNT OR DISMOUNT WHILE MOVING.



226-316

WARRANTY INFORMATION:

Read and understand the complete Warranty Statement found in this Manual. Fill out the Warranty Registration Form in full and return it to within 30 Days. Make certain the Serial Number of the Machine is recorded on the Warranty Card and on the Warranty Form that you retain.

DEALER'S PREDELIVERY SERVICE GUIDE

for the SCHULTE FLX15/ FLX10

DETAILS OF ITEMS LISTED BELOW ARE COVERED IN THIS OPERATOR'S MANUAL

- _____ Shipping damage corrected
 - _____ Set up machine as outlined in the shipping instructions attached to these instructions.
 - _____ Check that all safety decals are in good condition, replace if necessary.
 - _____ Check that gearboxes have been filled with oil.
 - _____ Check that all grease fittings have been lubricated.
-

DEALER'S DELIVERY GUIDE

for the SCHULTE FLX15/ FLX10

- _____ Mounting and removal from tractor
 - _____ Operation
 - _____ Adjustments
 - _____ Lubrication
 - _____ Maintenance
 - _____ Operator's safety precautions
 - _____ User's responsibility and warranty
 - _____ Operator's manual delivered to owner
 - _____ Operator instructed on contents of owner's manual
-

TABLE OF CONTENTS

SAFETY SECTION

Safety Decals	1-2
Safety Decal Location	1-14
Safety Information	1-16
Federal Laws and Regulations	1-20

INTRODUCTION SECTION 2-1

ASSEMBLY SECTION 3-1

Assembly From Shipping Position	3-2
Adjustments	3-3
Setting The Castor Wheels	3-3
Connection To Tractor	3-3
Connection To Cutter	3-4
Connection Strut To Cutter	3-5
Connecting Cutter Hoses To Hydraulic Breakaway Stand	3-5
General	3-6

OPERATION SECTION 4-1

MAINTENANCE SECTION 5-1

Condition of Nuts and Bolts	5-2
Castor Cone Spring Tension	5-2
Bolt Grade and Torque	5-2
Tires	5-2
Hubs and Spindles	5-2
Greasing Installations	5-2
Tightening Instructions For 618 Hubs	5-4
Hydraulics	5-4
Lubrication Gearbox	5-5
Universal Joint Assemblies	5-6
Frame Pivot Points Lube	5-6
Specifications	5-7

SAFETY SECTION

SAFETY

A safe and careful operator is the best operator. Safety is of primary importance to the manufacturer and should be to the owner/operator. Most accidents can be avoided by being aware of your equipment, your surroundings, and observing certain precautions. The first section of this manual includes a list of Safety Messages that, if followed, will help protect the operator and bystanders from injury or death. Read and understand these Safety Messages before assembling, operating or servicing this implement. This equipment should only be operated by those persons who have read the Manual, who are responsible and trained, and who know how to do so safely and responsibly.

The Safety Alert Symbol combined with a Signal Word, as seen below, is used throughout this manual and on decals which are attached to the equipment. The Safety Alert Symbol means: **“ATTENTION! BECOME ALERT! YOUR SAFETY IS INVOLVED!”** The Symbol and Signal Word are intended to warn the owner/operator of impending hazards and the degree of possible injury faced when operating this equipment..

Practice all usual and customary safe working precautions and above all---remember safety is up to YOU. Only YOU can prevent serious injury or death from unsafe practices.

CAUTION!

The lowest level of Safety Message; warns of possible injury. Decals located on the Equipment with this Signal Word are Black and Yellow.



WARNING!

Serious injury or possible death! Decals are Black and Orange.



DANGER!

Imminent death/critical injury. Decals are Red and White. (SG-1)



READ, UNDERSTAND, and FOLLOW the following Safety Messages. Serious injury or death may occur unless care is taken to follow the warnings and instructions stated in the Safety Messages. Always use good common sense to avoid hazards.

(SG-2)

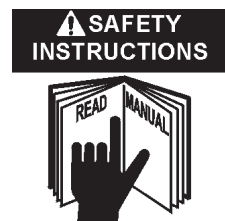

SAFETY

SAFETY

PELIGRO!



Si no lee Ingles, pida ayuda a alguien que si lo lea para que le traduzca las medidas de seguridad. (SG-3)

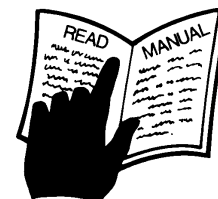

!LEA EL INSTRUCTIVO!

DANGER!



Never operate the Tractor or Implement until you have read and completely understand this Manual, the Tractor Operator's Manual, and each of the Safety Messages found in the Manual or on the Tractor and Implement. Learn how to stop the tractor engine suddenly in an emergency. Never allow inexperienced or untrained personnel too operate the Tractor and Implement without supervision. Make sure the operator has fully read and understood the manuals prior to operation. (SG-4)



WARNING!



Always maintain the safety decals in good readable condition. If the decals are missing, damaged, or unreadable, obtain and install replacement decals immediately. (SG-5)

WARNING!



Make certain that the "Slow Moving Vehicle" (SMV) sign is installed in such a way as to be clearly visible and legible. When transporting the Equipment use the Tractor flashing warning lights and follow all local traffic regulations. (SG-6)

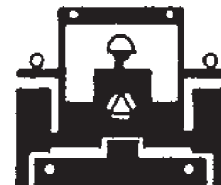

WARNING!



Operate this Equipment only with a Tractor equipped with an approved roll-over-protective system (ROPS). Always wear seat belts. Serious injury or even death could result from falling off the tractor-particularly during a turnover when the operator could be pinned under the ROPS. (SG-7)



WARNING!



Do not modify or alter this Implement. Do not permit anyone to modify or alter this Implement, any of its components or any Implement function. (SG-8)

DANGER!



BEFORE leaving the tractor seat, always engage the brake and/or set the tractor transmission in parking gear, disengage the PTO, stop the engine, remove the key, and wait for all moving parts to stop. Place the tractor shift lever into a low range or parking gear to prevent the tractor from rolling. Never dismount a Tractor that is moving or while the engine is running. Operate the Tractor controls from the tractor seat only. (SG-9)

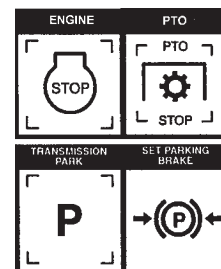

DANGER!



Never allow children or other persons to ride on the Tractor or Implement. Falling off can result in serious injury or death. (SG-10)



SAFETY

SAFETY

DANGER!



Never allow children to operate or ride on the Tractor or Implement. (SG-11)



WARNING!



Do not mount the Tractor while the tractor is moving. Mount the Tractor only when the Tractor and all moving parts are completely stopped. (SG-12)



DANGER!



Start tractor only when properly seated in the Tractor seat. Starting a tractor in gear can result in injury or death. Read the Tractor operators manual for proper starting instructions. (SG-13)



DANGER!



Never work under the Implement, the framework, or any lifted component unless the Implement is securely supported or blocked up to prevent sudden or inadvertent falling which could cause serious injury or even death. (SG-14)



DANGER!



Do not operate this Equipment with hydraulic oil leaking. Oil is expensive and its presence could present a hazard. Do not check for leaks with your hand! Use a piece of heavy paper or cardboard. High-pressure oil streams from breaks in the line could penetrate the skin and cause tissue damage including gangrene. If oil does penetrate the skin, have the injury treated immediately by a physician knowledgeable and skilled in this procedure. (SG-15)



WARNING!



The operator and all support personnel should wear hard hats, safety shoes, safety glasses, and proper hearing protection at all times for protection from injury including injury from items thrown by the equipment. (SG-16)

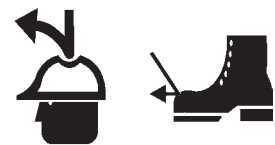

SAFETY

CAUTION!



PROLONGED EXPOSURE TO LOUD NOISE MAY CAUSE PERMANENT HEARING LOSS! Tractors with or without an Implement attached can often be noisy enough to cause permanent hearing loss. We recommend that you always wear hearing protection if the noise in the Operator's position exceeds 80db. Noise over 85db over an extended period of time will cause severe hearing loss. Noise over 90db adjacent to the Operator over an extended period of time will cause permanent or total hearing loss. *Note:* Hearing loss from loud noise [from tractors, chain saws, radios, and other such sources close to the ear] is cumulative over a lifetime without hope of natural recovery. (SG-17)



WARNING!



Transport only at safe speeds. Serious accidents and injuries can result from operating this equipment at unsafe speeds. Understand the Tractor and Implement and how it handles before transporting on streets and highways. Make sure the Tractor steering and brakes are in good condition and operate properly.



Before transporting the Tractor and Implement, determine the safe transport speeds for you and the equipment. Make sure you abide by the following rules:

1. Test the tractor at a slow speed and increase the speed slowly. Apply the Brakes smoothly to determine the stopping characteristics of the Tractor and Implement. As you increase the speed of the Tractor the stopping distance increases. Determine the maximum safe transport speed for you and this Equipment.
2. Test the equipment at a slow speed in turns. Increase the speed through the turn only after you determine that it is safe to operate at a higher speed. Use extreme care and reduce your speed when turning sharply to prevent the tractor and implement from turning over. Determine the maximum safe turning speed for you and this equipment before operating on roads or uneven ground.
3. Only transport the Tractor and Implement at the speeds that you have determined are safe and which allow you to properly control the equipment.



Be aware of the operating conditions. Do not operate the Tractor with weak or faulty brakes. When operating down a hill or on wet or rain slick roads, the braking distance increases: use extreme care and reduce your speed. When operating in traffic always use the Tractor's flashing warning lights and reduce your speed. Be aware of traffic around you and watch out for the other guy. (SG-19)

WARNING!



Never attempt to lubricate, adjust, or remove material from the Implement while it is in motion or while tractor engine is running. Make sure the tractor engine is off before working on the Implement. (SG-20)

WARNING!



Always read carefully and comply fully with the manufacturers instructions when handling oil, solvents, cleansers, and any other chemical agent. (SG-22)



SAFETY

SAFETY

WARNING!



Periodically inspect all moving parts for wear and replace when necessary with authorized service parts. Look for loose fasteners, worn or broken parts, and leaky or loose fittings. Make sure all pins have cotter pins and washers. Serious injury may occur from not maintaining this machine in good working order. (SG-21)



DANGER!



Never run the tractor engine in a closed building or without adequate ventilation. The exhaust fumes can be hazardous to your health.

(SG-23)

DANGER!



KEEP AWAY FROM ROTATING ELEMENTS to prevent entanglement and possible serious injury or death.

(SG-24)



DANGER!



Never allow children to play on or around Tractor or Implement. Children can slip or fall off the Equipment and be injured or killed. Children can cause the Implement to shift or fall crushing themselves or others. (SG-25)

WARNING!



Do not exceed the rated PTO speed for the Implement. Excessive PTO speeds can cause Implement driveline or blade failures resulting in serious injury or death. (SG-26)

DANGER!



NEVER use drugs or alcohol immediately before or while operating the Tractor and Implement. Drugs and alcohol will affect an operator's alertness and coordination and therefore affect the operator's ability to operate the equipment safely. Before operating the Tractor or Implement, an operator on prescription or over-the-counter medication must consult a medical professional regarding any side effects of the medication that would hinder their ability to operate the Equipment safely. **NEVER** knowingly allow anyone to operate this equipment when their alertness or coordination is impaired. Serious injury or death to the operator or others could result if the operator is under the influence of drugs or alcohol. (SG-27)



DANGER!



Operate the Tractor and/or Implement controls only while properly seated in the Tractor seat with the seat belt securely fastened around you. Inadvertent movement of the Tractor or Implement may cause serious injury or death. (SG-29)

SAFETY

WARNING!



Engine Exhaust, some of its constituents, and certain vehicle components contain or emit chemicals known to the state of California to cause cancer and birth defects or other reproductive harm. (SG-30)

WARNING!



Battery posts, terminals and related accessories contain lead and lead compounds, chemicals known to the state of California to cause cancer and birth defects or other reproductive harm. Wash Hands after handling. (SG-31)

WARNING!



Prolonged operation may cause operator boredom and fatigue affecting safe operation. Take scheduled work breaks to help prevent these potentially impaired operating conditions. Never operate the Implement and Tractor in a fatigued or bored mental state which impairs proper and safe operation. (SG-32)

WARNING!



Use extreme caution when getting onto the Implement to perform repairs, maintenance and when removing accumulated material. Only stand on solid flat surfaces to ensure good footing. Use a ladder or raised stand to access high spots which cannot be reached from ground level. Slipping and falling can cause serious injury or death. (SG-33)

WARNING!



Avoid contact with hot surfaces including hydraulic oil tanks, pumps, motors, valves and hose connections. Relieve hydraulic pressure before performing maintenance or repairs. Use gloves and eye protection when servicing hot components. Contact with a hot surface or fluid can cause serious injury from burns or scalding. (SG-34)

WARNING!



Perform service, repairs and lubrication according to the maintenance section. Ensure the unit is properly lubricated as specified in the lubrication schedule and all bolts and nuts are properly torqued. Failure to properly service, repair and maintain this Implement in good operating condition could cause component failure and possible serious injury or even death. (SG-35)

DANGER!



DO NOT operate this Implement on a Tractor that is not properly maintained. Should a mechanical or Tractor control failure occur while operating, immediately shut down the Tractor and perform repairs before resuming operation. Serious injury and possible death could occur from not maintaining this Implement and Tractor in good operating condition. (SG-36)

SAFETY

SAFETY

WARNING!



Mow only in conditions where you have clear visibility in daylight or with adequate artificial lighting. Never mow in darkness or foggy conditions where you cannot clearly see at least 100 yards in front and to the sides of the tractor and mower. Make sure that you can clearly see and identify passersby, steep slopes, ditches, drop-offs, overhead obstructions, power lines, debris and foreign objects. If you are unable to clearly see this type of items discontinue mowing. (SGM-1)

DANGER!



There are obvious and hidden potential hazards in the operation of this Mower. REMEMBER! This machine is often operated in heavy brush and in heavy weeds. The Blades of this Mower can throw objects if shields are not properly installed and maintained. Serious injury or even death may occur unless care is taken to insure the safety of the operator, bystanders, or passersby in the area. Do not operate this machine with anyone in the immediate area. Stop mowing if anyone is within 100 yards of mower. (SGM-2)



DANGER!



All Safety Shields, Guards and Safety devices including (but not limited to) - the Deflectors, Chain Guards, Steel Guards, Gearbox Shields, PTO integral shields, and Retractable Door Shields should be used and maintained in good working condition. All safety devices should be inspected carefully at least daily for missing or broken components. Missing, broken, or worn items must be replaced at once to reduce the possibility of injury or death from thrown objects, entanglement, or blade contact. (SGM-3)

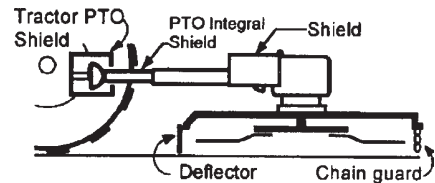

DANGER!



The rotating parts of this machine have been designed and tested for rugged use. However, the blades could fail upon impact with heavy, solid objects such as metal guard rails and concrete structures. Such impact could cause the broken objects to be thrown outward at very high velocities. To reduce the possibility of property damage, serious injury, or even death, never allow the cutting blades to contact such obstacles. (SGM-4)

WARNING!



Extreme care should be taken when operating near loose objects such as gravel, rocks, wire, and other debris. Inspect the area before mowing. Foreign objects should be removed from the site to prevent machine damage and/or bodily injury or even death. Any objects that cannot be removed must be clearly marked and carefully avoided by the operator. Stop mowing immediately if blades strike a foreign object. Repair all damage and make certain rotor or blade carrier is balanced before resuming mowing. (SGM-5)

WARNING!



Many varied objects, such as wire, cable, rope, or chains, can become entangled in the operating parts of the mower head. These items could then swing outside the housing at greater velocities than the blades. Such a situation is extremely hazardous and could result in serious injury or even death. Inspect the cutting area for such objects before mowing. Remove any like object from the site. Never allow the cutting blades to contact such items. (SGM-6)



SAFETY

WARNING!



Mow at the speed that you can safely operate and control the tractor and mower. Safe mowing speed depends on terrain condition and grass type, density, and height of cut. Normal ground speed range is from 0 to 5 mph. Use slow mowing speeds when operating on or near steep slopes, ditches, drop-offs, overhead obstructions, power lines, or when debris and foreign objects are to be avoided. (SGM-7)

WARNING!



Avoid mowing in reverse direction when possible. Check to make sure there are no persons behind the mower and use extreme care when mowing in reverse. Mow only at a slow ground speed where you can safely operate and control the tractor and mower. Never mow an area that you have not inspected and removed debris or foreign material. (SGM-8)

WARNING!



Do not put hands or feet under mower decks. Blade Contact can result serious injury or even death. Stay away until all motion has stopped and the decks are securely blocked up. (SGM-9)

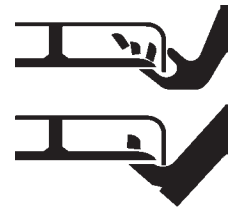

DANGER!



Replace bent or broken blade with new blades. NEVER ATTEMPT TO STRAIGHTEN OR WELD ON BLADES SINCE THIS WILL LIKELY CRACK OR OTHERWISE DAMAGE THE BLADE WITH SUBSEQUENT FAILURE AND POSSIBLE SERIOUS INJURY FROM THROWN BLADES. (SGM-10)

WARNING!



Do not mow with two machines in the same area except with Cab tractors with the windows closed. (SGM-11)

WARNING!



Follow these guidelines to reduce the risk of equipment and grass fires while operating, servicing, and repairing the Mower and Tractor:

- Equip the Tractor with a fire extinguisher in an accessible location.
- Do Not operate the Mower on a Tractor with an underframe exhaust.
- Do Not smoke or have an open flame near the Mower and Tractor.
- Do Not drive into burning debris or freshly burnt areas.
- Ensure slip clutches are properly adjusted to prevent excessive slippage and plate heating.
- Never allow clippings or debris to collect near drivelines, slip clutches, and gearboxes. Periodically shut down the Tractor and Mower and clean clippings and collected debris from the mower deck. (SGM-12)



WARNING!



DO NOT weld or repair rotating mower components. Welds and other repairs may cause severe vibration and/or component failure resulting in parts being thrown from the mower causing serious bodily injury. See your Authorized Dealer for proper repairs. (SGM-13)

DANGER!



The Mower is designed for certain mowing applications and is rated to cut up to a specific size vegetation (see Mower Standard Equipment and Specifications). DO NOT use this Mower to cut vegetation above the Mower's rated capacity or to cut any type of non-vegetative material. Only operate this Mower on a properly sized and equipped Tractor. Operating this Mower in an application for which it is not designed and/or operating the Mower with the wrong size Tractor can cause Mower component damage and equipment failure resulting in possible serious injury or death. (SGM-14)

SAFETY

SAFETY

DANGER!



Always disconnect the main PTO Driveline from the Tractor before performing service on the Mower. Never work on the Mower with the tractor PTO driveline connected and running. Blades or Drivelines could turn without warning and cause immediate entanglement, injury or death.

(SRM-3)

DANGER!



Do not turn so sharp or lift mower so high to produce a severe "knocking" of the Driveline which will cause accelerated wear and breakage of drive train components and could result in possible injury from the separated Driveline sections. (SRM-4)

WARNING!



Do not let the Blades turn when the Mower Deck is raised for any reason, including clearance or for turning. Raising the Mower deck exposes the Cutting Blades which creates a potentially serious hazard and could cause serious injury or even death from objects thrown from the Blades. (SRM-7)



DANGER!



Rotary Mowers are capable under adverse conditions of throwing objects for great distances (100 yards or more) and causing serious injury or death. Follow safety messages carefully



STOP MOWING IF PASSERSBY ARE WITHIN 100 YARDS UNLESS:

- Front and Rear Deflectors, Chain Guards, or Bands are installed and in good, workable condition;
- Mower sections or Wings are running close to and parallel to the ground without exposed Blades;
- Passerby are outside the existing thrown-object zone;
- All areas have been thoroughly inspected and all foreign material such as rocks, cans, glass, and general debris has been removed.

NOTE: Where there are grass and weeds high enough to hide debris that could be struck by the blades, the area should be: inspected and large debris removed, mowed at an intermediate height, inspected, closely with any remaining debris being removed, and mowed again at desired final height. (This will also reduce power required to mow, reduce wear and tear on the Mower drivetrain, spread cut material better, eliminate streaking, and make the final cut more uniform.)

(SRM-1)

DANGER!



Be particularly careful when transporting the Implement using the tractor. Turn curves or go up or down hills only at a low speed and at a gradual steering angle. Make certain that at least 20% of the tractor's weight is on the front wheels to maintain safe steering. Slow down on rough or uneven surfaces. (STI-1)

DANGER!



When the Wings are folded for transport, the center of gravity is raised and the possibility of overturn is increased. Drive slowly and use extreme caution when turning on hillsides. Overturning the Implement could cause the Implement to overturn the Tractor and vice versa resulting in serious injury or even death. Never fold wings on a hillside...the Implement may overturn. (STI-2)

SAFETY

DANGER!



DO NOT allow any person under a folded wing unless wing is securely locked up or supported. **DO NOT** approach the Implement unless the Tractor is turned off and all motion has ceased. Never work under the frame work, or any lifted component unless the implement is securely supported or blocked up. A sudden or inadvertent fall by any of these components could cause serious injury or even death. (STI-3)



SAFETY

WARNING!



Never unhitch without using the Tongue Jack. The Tongue is very heavy. Attempting to lift the Tongue without using the Tongue Jack could cause **strains or other injury**. Allowing the tongue to fall **suddenly and unexpectedly** could result in **crushing injury**. Use the Tongue Jack for **lifting the Implement only**. Overloading the Tongue Jack can cause failure with possible **serious bodily injury or even death**. (STI-4)

CAUTION!



On a fully-assembled unit, do not remove the Wing Retaining Strap until hoses are attached to the tractor and the Wing Cylinders are filled with oil. Lower the Wings slowly and carefully. Keep bystanders away during operations. (STI-5)

WARNING!



Secure the Implement for transport before traveling on public roads. For pull-type Implements, secure the center axle using cylinder stops or transport pin and properly attach a safety chain between the Implement and Tractor. Secure wings in upright position on folding Implements using wing transport locks. (STI-7)

DANGER!



Do not operate the implement while wearing loose fitting clothing. Entanglement of the clothing with the rotating elements can result in serious injury or even death. Stay clear of all rotating elements at all times. (SSP-3)

WARNING!



Use extreme care when lowering or unfolding the implement's wings. Make sure no bystanders are close by or underneath the wings. Allow ample clearance around the implement when folding or unfolding the wings. Use extreme caution around buildings or overhead power lines.

(S3PT-5)

DANGER!



Make sure the PTO shield, integral driveline shields, and input shields are installed when using PTO-driven equipment. Always replace any shield if it is damaged or missing. (S3PT-8)



SAFETY

SAFETY

WARNING!



Relieve hydraulic pressure prior to doing any maintenance or repair work on the Implement. Place the Implement on the ground or securely blocked up, disengage the PTO, and turn off the tractor engine. Push and pull the Remote Cylinder lever in and out several times prior to starting any maintenance or repair work. (S3PT-9)



WARNING!



The rotating parts of this machine continue to rotate even after the PTO has been turned off. The operator should remain in his seat for 60 seconds after the brake has been set, the PTO disengaged, the tractor turned off, and all evidence of rotation has ceased. (3PT-10)

“Wait a minute...Save a life!”

DANGER!



Always disconnect the main PTO Driveline from the Tractor before performing service on the Implement. Never work on the Implement with the tractor PTO driveline connected and running. Rotating Parts, Blades or Drivelines could turn without warning and cause immediate entanglement, injury or death. (S3PT-11)

DANGER!



This Implement is wider than the Tractor. Be careful when operating or transporting this equipment to prevent the Implement from running into or striking sign posts, guard rails, concrete abutments or other solid objects. Such an impact could cause the Implement and Tractor to pivot violently resulting in loss of steering control, serious injury, or even death. Never allow the Implement to contact obstacles. (S3PT-12)

WARNING!



Before operating the Mower, check to make sure the Implement input driveline will not bottom out or become disengaged. Bottoming out occurs when the inner shaft penetrates the outer housing until the assembly becomes solid-it can shorten no more. Bottoming out can cause serious damage to the Tractor PTO by pushing the PTO into the Tractor and through the support bearings or downward onto the PTO shaft, breaking it off. A broken drive line can cause personal injury. (S3PT-18)

WARNING!



Allow sufficient clearance for the Implement to swing outward while turning. Implements carried behind the Tractor will swing outside the tire path when making turns. Contacting a solid object while turning will cause equipment damage and possible injury. (S3PT-20)

WARNING!



DO NOT use a PTO adapter to attach a non-matching Implement driveline to a Tractor PTO. Use of an adapter can double the operating speed of the Mower resulting in excessive vibration, thrown objects, and blade and mower failure. Adapter use will also change the working length of the driveline exposing unshielded driveline areas. Serious bodily injury and/or equipment failure can result from using a PTO adapter. Consult an authorized dealer for assistance if the Implement driveline does not match the Tractor PTO. (S3PT-14)

SAFETY

WARNING!



Relieve hydraulic pressure prior to doing any maintenance or repair work on the Implement. Place the Mower Head on the ground or securely supported on blocks or stands, disengage the PTO, and turn off the engine. Push and pull the control Levers or Joystick several times to relieve pressure prior to starting any maintenance or repair work. (SBM-6)

DANGER!



Always shut the Tractor completely down, place the transmission in park, and set the parking brake before you or anyone else attempts to connect or disconnect the Implement and Tractor hitches. (S3PT-15)

WARNING!



When attaching the Implement input driveline to the Tractor PTO, it is important that the connecting yoke spring activated locking collar slides freely and the locking balls are seated securely in the groove on the Tractor PTO shaft. A driveline not attached correctly to the Tractor PTO shaft could come loose and result in personal injury and damage to the Implement. (S3PT-17)

WARNING!



Only tow the Implement behind a properly sized and equipped Tractor which exceeds the weight of the Implement by at least 20%. DO NOT tow the Implement behind a truck or other type of vehicle. Never tow the Implement and another Implement connected in tandem. Never tow the Implement at speeds over 20 MPH. (STI-6)

PARTS INFORMATION

Schulte Products use balanced and matched system components for blade carriers, blades, cuttershafts, knives, knife hangers, rollers, drivetrain components, and bearings. These parts are made and tested to Schulte Industry specifications. Non-genuine "will fit" parts do not consistently meet these specifications. The use of "will fit" parts may reduce the performance, void Schulte warranties, and present a safety hazard. Use genuine Schulte parts for economy and safety.

(SPSI-1)

SEE YOUR SCHULTE DEALER

In addition to the design and configuration of this Implement, including Safety Signs and Safety Equipment, hazard control and accident prevention are dependent upon the awareness, concern, prudence, and proper training of personnel involved in the operation, transport, maintenance, and storage of the machine. Refer also to Safety Messages and operation instruction in each of the appropriate sections of the Tractor and Equipment Manuals. Pay close attention to the Safety Signs affixed to the Tractor and Equipment. (SG-18)

SAFETY

SAFETY

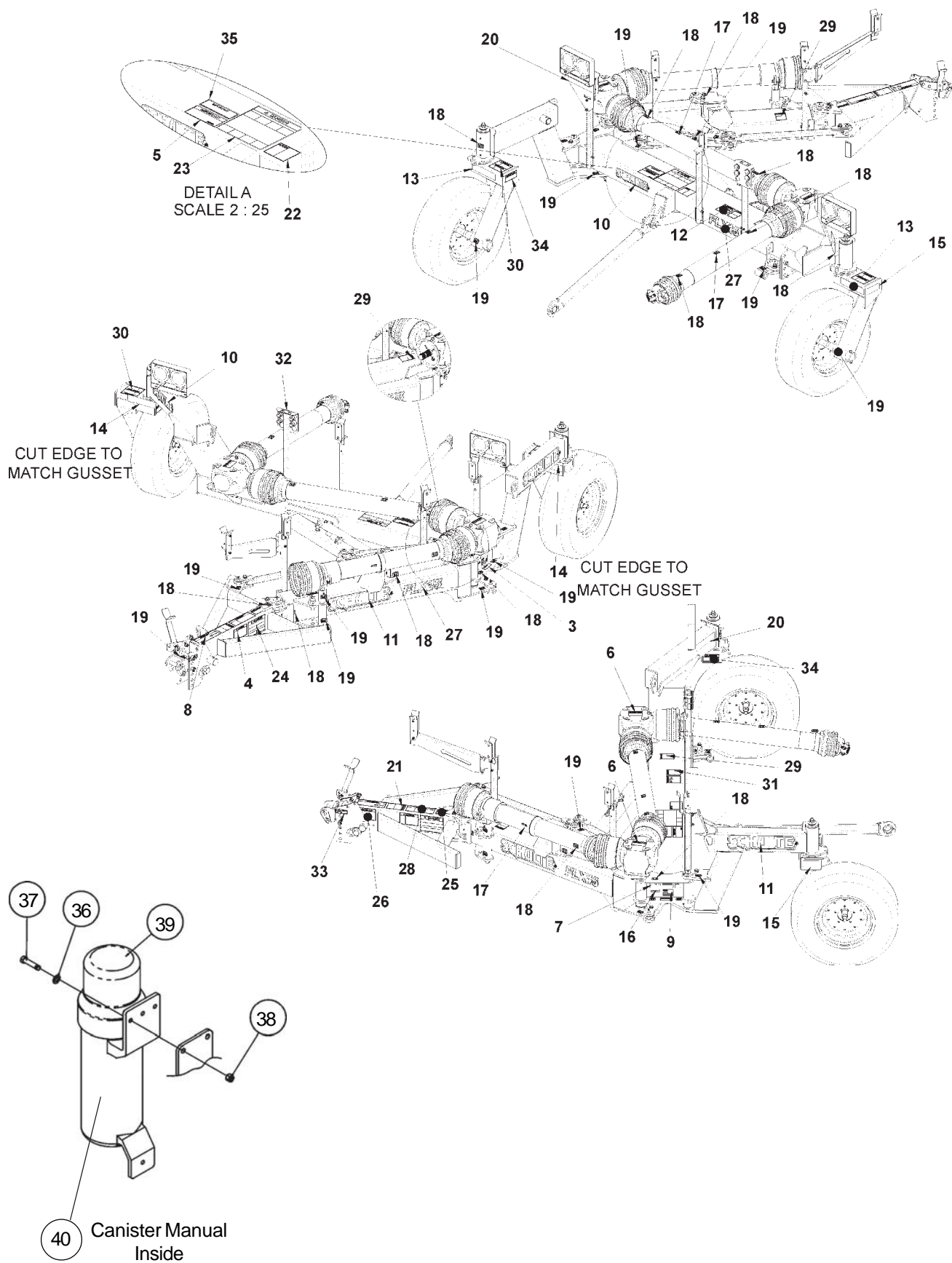

SAFETY

SAFETY

ITEM	PART NO.	QTY.	DESCRIPTION
1			
2	226-004	1	Fema Member
3	226-044	1	Decal, Grease Nipple On Underside
4	226-048	1	Decal, Warning Transport Speed
5	226-049	1	Decal, Use Genuine Schulte Parts
6	226-081	2	Decal, Check Oil Level
7	226-084	1	Decal, Made In North America
8	226-085	1	Decal, Minimum Lubrication Requirements
9		1	Serial Plate
10	226-117	2	Decal, Schulte Logo, Medium Profile
11	226-118	2	Decal, Schulte Logo, Large Profile
12	226-148	1	Decal, Warning Hydraulic Pressure
13	226-153	2	Red Reflector
14	226-154	2	Amber Reflector
15	226-1541	2	Amber Reflector
16	226-353	1	Decal, Patent Numbers
17	226-180	3	Decal, 4 Hour Greasing
18	226-181	13	Decal, 8 Hour Greasing
19	226-182	13	Decal, 50 Hour Greasing
20	226-189	2	Fluorescent
21	226-191	1	Decal, Peligro Read Manual
22	226-314	1	Decal, Peligro Driveline Manual
23	226-316	1	Decal, Danger Multi Warning
24	226-317	1	Decal, Danger Driveline Maintenance
25	226-318	1	Decal, Notice To Owner
26	226-323	1	Decal, Drawbar Adjustment
27	226-325	2	Decal, FLX15 Logo
28	226-327	1	Decal, Warning Transport Speed
29	226-328	3	Decal, Danger If Guard Missing Or Damaged
30	226-330	2	Decal, Warning Shear Hazard
31	226-332	1	Decal, Warning Blade Rotation
32	226-337	1	Color Coded Hose Ends
33	226-338	1	Maximum Operating Speed
34	226-341	2	Check Tire Pressure
35	226-364	1	Flex Arm Shaft Greasing Decal
36	256-018	3	Flatwasher 1/4"
37	250-002	3	Bolt 1/4"
38	255-025	3	Locknut
39	280-201	1	Canister
40	A101-01-0C	1	Operators Manual

NOTE: Schulte supplies safety decals on this product to promote safe operation. Damage to the decals may occur while in shipping, use, or reconditioning. Schulte cares about the safety of its customers, operators, and bystanders, and will replace the safety decals on this product in the field, free of charge (Some shipping and handling charges may apply). Contact your Schulte dealer to order replacement decals.

SAFETY

SAFETY

Item 2: FEMA MEMBER DECAL



P/N 226-004

Item 3: Grease Nipple on Underside. Apply grease as specified in Owner's Manual.

IMPORTANT
GREASE NIPPLE ON UNDERSIDE
REFER TO OWNER'S MANUAL

226-044

P/N 226-044

Item 4: DO NOT transport at speeds higher than 20 mph. Only transport behind a properly sized and equipped tractor.

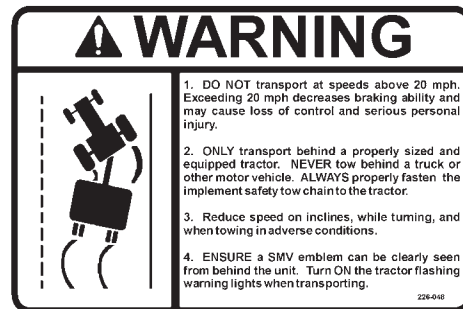

P/N 226-048

Item 5: For safety and to guarantee optimum product reliability always use genuine SCHULTE replacement parts.

IMPORTANT
For your safety and to guarantee optimum product reliability, always use Genuine SCHULTE replacement parts. The use of inferior "will-fit" parts will void Warranty of your SCHULTE implement and may cause premature or catastrophic failure which can result in serious injury or death. If you have any questions concerning the repair parts you are using, contact Schulte Industries Ltd, Englefeld SK Canada 50K 1N0 1-800-404-6044

SCHULTE

226-049

P/N 226-049

SAFETY

SAFETY

Item 6: Grease Every 8hrs.

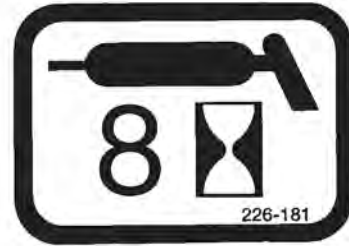

P/N 226-181

Item 7: Made In North America



P/N 226-084

Item 8: IMPORTANT! Minimum Lubrication Requirements



P/N 226-085

Item 10: LOGO NAME SCHULTE Medium.



P/N 226-117

SAFETY

SAFETY

Item 11: LOGO NAME SCHULTE
Large



P/N 226-118

Item 12: WARNING; High-Pressure Fluid
Hazard



P/N 226-148

Item 13: Red Reflector 2"x9". Keep reflectors clean and visible.

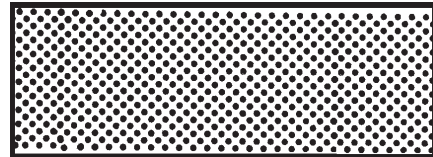

P/N 226-153

Item 14: Amber Reflector 2"x9". Keep reflectors clean and visible.

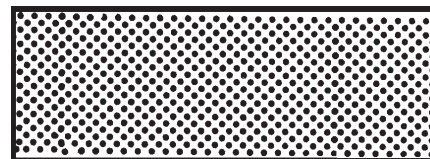

P/N 226-154

SAFETY

SAFETY

Item 15: Amber Reflector 2"x4-1/2". Keep reflectors clean and visible.

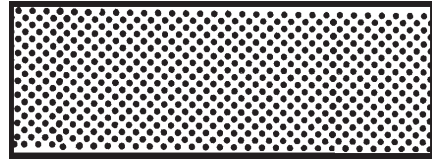

P/N 226-1541

Item 16: Patent Numbers

THIS PRODUCT IS PROTECTED
BY USA PATENT # 6,739,612

226-353

P/N 226-353

Item 17: Grease Every 4 hrs.

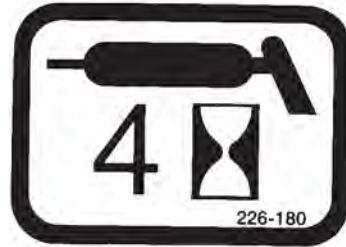

226-180

P/N 226-180

Item 18: Grease Every 8hrs.

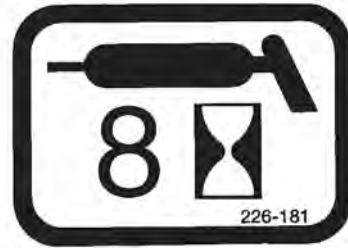

226-181

P/N 226-181

SAFETY

SAFETY

Item 19: Grease Every 50hrs.



P/N 226-182

Item 20: Fluorescent Reflector 2" X 9". Keep reflectors clean and visible.



P/N 226-189

Item 21: Peligro Translation, If you do not know how to read english. Please find someone that knows how to read english.

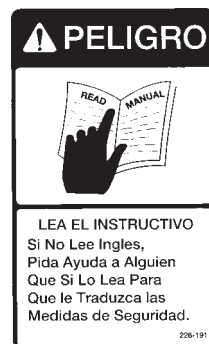

P/N 226-191

Item 22 : Peligro Driveline Safety

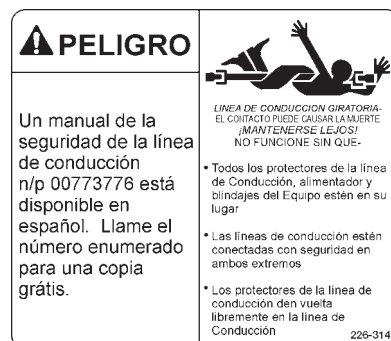

P/N 226-314

SAFETY

SAFETY

Item 23: Multi-Hazard Decal



Item 24: Make certain that drivelines are correct length and are securely attached.



Item 25: Operator's Manual (with repair parts) and warranty was attached to this implement during final inspection.



Item 26: IMPORTANT! Drawbar Length Required For Pull Type Unit.

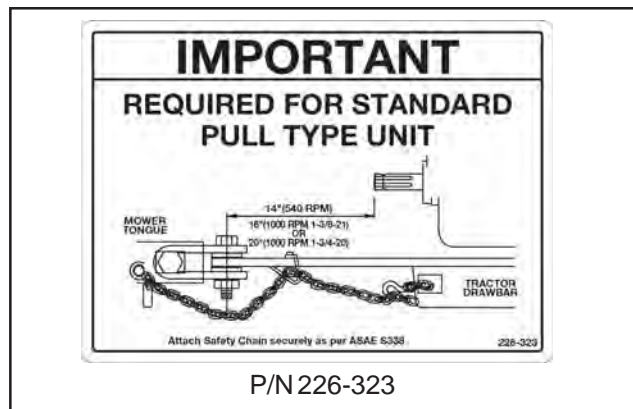

SAFETY

SAFETY

Item 27: DECAL NAME FLX15

FLX15
FLX10

P/N 226-325

Item 28: Reduce transport speed when traveling along side of road edge to maintain proper control of Flex Arm Mower



P/N 226-327

Item 29: DANGER! If guard missing or damaged DO NOT Operate.



P/N 226-328

Item 30: WARNING Keep away from wheel stabilizer holes to prevent crushing or shearing off.



P/N 226-330

SAFETY

SAFETY

Item 31: WARNING: To reduce serious bodily injury from thrown objects the direction of blades should be as shown on decal.

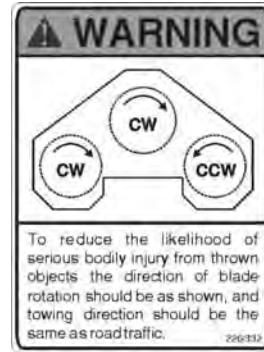

P/N 226-332

Item 32: Color Coded Hose Ends

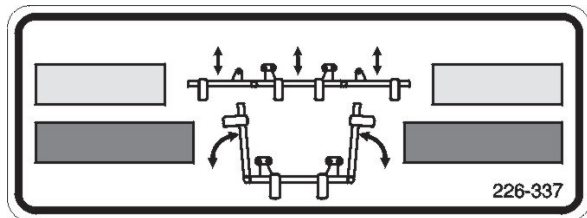

P/N 226-337

Item 33: IMPORTANT! For optimal Performance, use a maximum forward speed of 4 mph (6.4 km/h)



P/N 226-338

Item 34: IMPORTANT! Check Tire Pressure Maintain 40 PSI (276 kpa) or Damage Will Occur.



P/N 226-341

SAFETY

SAFETY

Item35 : IMPORTANT! Apply grease to cross shaft in the collapsed and extended position every 4 hours.

IMPORTANT

Apply grease to cross shaft in the collapsed and extended positions every 4 hours

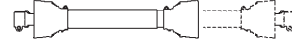

226-364

P/N 226-364

SAFETY

FEDERAL LAWS AND REGULATIONS

This section is intended to explain in broad terms the concept and effect of federal laws and regulations concerning employer and employee equipment operators. This section is not intended as a legal interpretation of the law and should not be considered as such.

Employer-Employee Operator Regulations

U.S. Public Law 91-596 (The Williams-Steiger Occupational and Health Act of 1970) OSHA

This Act Seeks:

“...to assure so far as possible every working man and woman in the nation safe and healthful working conditions and to preserve our human resources...”

DUTIES

Sec. 5 (a) Each employer-

- (1) shall furnish to each of his employees employment and a place of employment which are free from recognized hazards that are causing or are likely to cause death or serious physical harm to his employees;
- (2) shall comply with occupational safety and health standards promulgated under this Act.
- (b) Each employee shall comply with occupational safety and health standards and all rules, regulations and orders issued pursuant to this Act which are applicable to his own actions and conduct.

OSHA Regulations

OSHA regulations state in part: “At the time of initial assignment and at least annually thereafter, the employer shall instruct every employee in the safe operation and servicing of all equipment with which the employee is, or will be involved.”

Employer Responsibilities:

To ensure employee safety during Tractor and Implement operation, it is the employer’s responsibility to:

1. Train the employee in the proper and safe operation of the Tractor and Implement.
2. Require that the employee read and fully understand the Tractor and Implement Operator’s manual.
3. Permit only qualified and properly trained employees to operate the Tractor and Implement.
4. Maintain the Tractor and Implement in a safe operational condition and maintain all shields and guards on the equipment.
5. Ensure the Tractor is equipped with a functional ROPS and seat belt and require that the employee operator securely fasten the safety belt and operate with the ROPS in the raised position at all times.
6. Forbid the employee operator to carry additional riders on the Tractor or Implement.
7. Provide the required tools to maintain the Tractor and Implement in a good safe working condition and provide the necessary support devices to secure the equipment safely while performing repairs and service.
8. Require that the employee operator stop mowing if bystanders or passerbys come within 100 yards.

Child Labor Under 16 Years of Age

Some regulations specify that no one under the age of 16 may operate power machinery. It is your responsibility to know what these regulations are in your own area or situation. (Refer to U.S. Dept. of Labor, Employment Standard Administration, Wage & Home Division, Child Labor Bulletin #102.)

SAFETY

SAFETY

INTRODUCTION SECTION

INTRODUCTION

INTRODUCTION

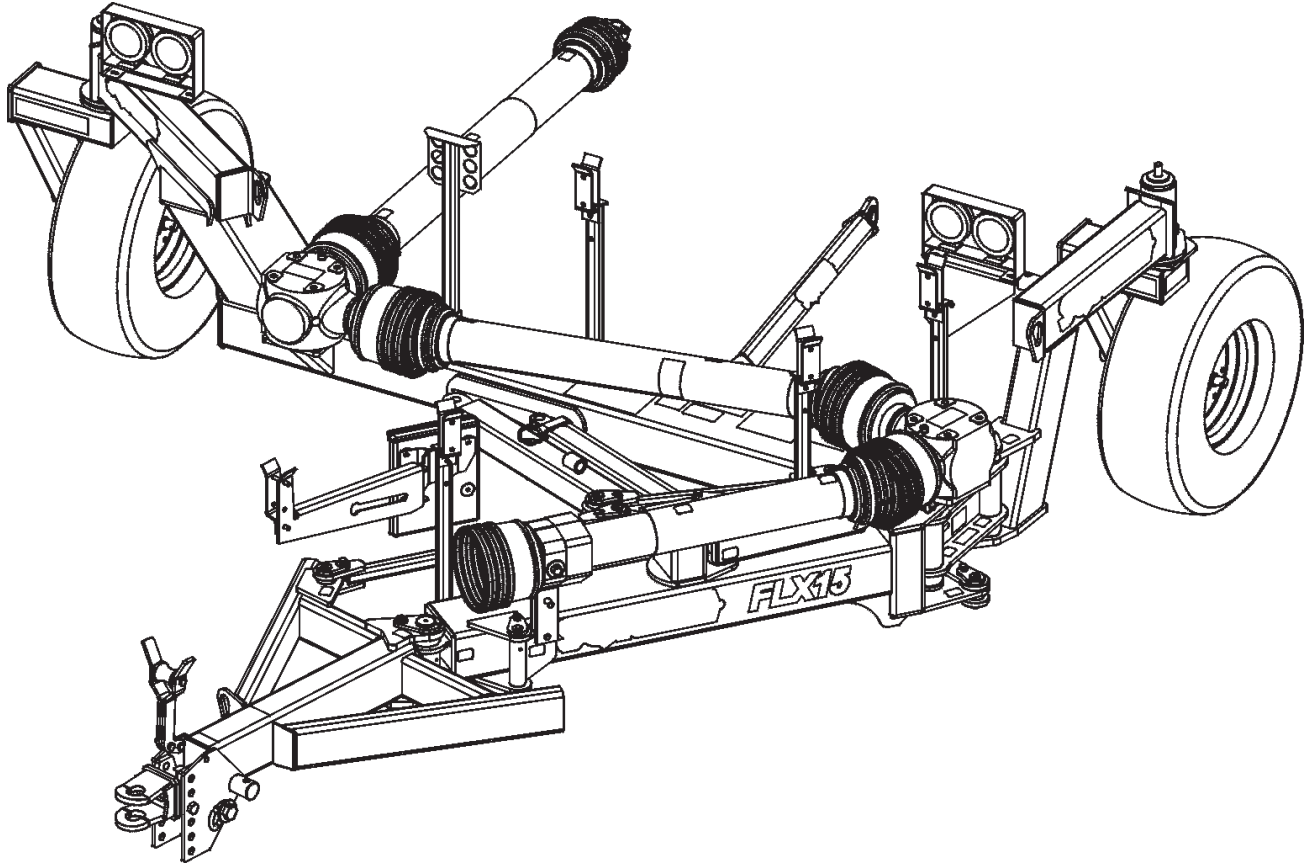

Your Flex Arm is designed to attach a Schulte 10' or 15' cutter it is primarily for weeds, grass, and brush up to 2" in diameter. The Flex Arm allows the operator to travel on the road while the 10' or 15' cutter cuts the ditch slope. With proper maintenance as described in this manual, your Flex Arm and Cutter will provide you with years of dependable service with a minimum of repairs.

It is required that all operators of this implement read this manual or be instructed of its contents as to safety, proper operation, and maintenance before beginning operation.

Your Flex Arm and Cutter have been assembled for operation with a tractor PTO input speed of either 540 or 1000 RPM. Should you desire to change PTO input speed, contact your local Schulte dealer who will assist you in performing the necessary modifications. Use your existing CV driveline from your Schulte rotary cutter to connect the Flex Arm to the tractor.

When ordering parts for the Gearboxes and the Drivelines, be sure to specify the serial number. The serial number is located on the left hand side attached to the Flex Arm frame.

Driveline Integral Shields, and Gearbox Shields are standard equipment and are to be used at all times.

To place warranty into effect, fill out the warranty validation form in full and return it within thirty (30) days of the date of purchase

INTRODUCTION

ATTENTION OWNER/OPERATOR

BEFORE OPERATING THIS MACHINE:

1. Carefully read the Operator's Manual, completely understand the Safety Messages and instructions, and know how to operate correctly both the tractor and Mower.
2. Fill out the Warranty Card in full. Be sure to answer all questions, including the Serial Number. Mail within 30 days of delivery date of this implement.

NOTE: Warranties are honored only if completed "Owner Registration and Warranty" forms are received by Schulte within thirty days of delivery of the flexarm.

3. Record the Model and Serial Numbers on the Warranty page at the front of the Operator's Manual. Keep this as part of the permanent maintenance file for the flexarm.

IMPORTANT

For your safety and to guarantee optimum product reliability, always use Genuine SCHULTE replacement parts. The use of inferior "will-fit" parts will void Warranty of your SCHULTE implement and may cause premature or catastrophic failure which can result in serious injury or death. If you have any questions concerning the repair parts you are using, contact Schulte Industries Ltd, Englefeld SK Canada S0K 1N0
1-800-404-6044

SCHULTE

225-049

INTRODUCTION

**ASSEMBLY
SECTION**

ASSEMBLY

1. From Shipping Position (FLX15/10)

The Flex arms will be shipped almost completely assembled. Remove the flex arm from the trailer using an overhead boom. Attach chains to the flex arm using the three lifting hooks in the locations shown. The lengths of the chains may need to be adjusted to provide a level lift of the flex arm.

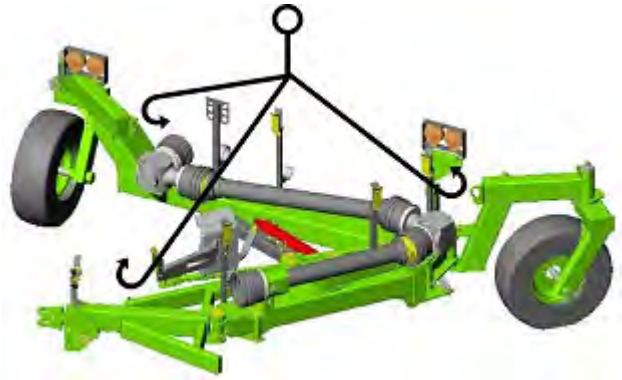

ASSEMBLY

Use the following procedure to get your implement field ready.

Block the flex arm under the frame at point "A".

Remove the four shipping brackets, "B" and discard.

Break the bands securing the arm strut "C" and the castor link * "D".

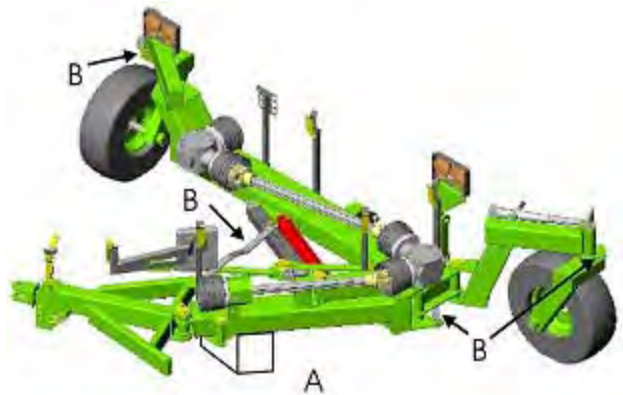

Swing the hitch forward and connect the arm strut to hitch at point "E". Use the 1/2" bolt, lock washer, and flat washer to tighten the pin.

Connect the castor link to the castor arm at point "F" using the provided pin and hardware. * Face the pinhead upwards.

Connect to the tractor drawbar and remove the blocking.

Drive the flex arm ahead to straighten the left wheel standard. *

Connect the other end of the castor link to the arm frame "G" using the provided pin and hardware. *

* Does not apply to the FLX10.

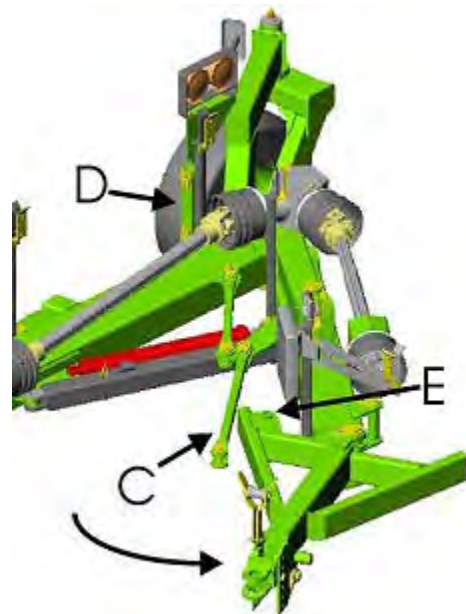

ASSEMBLY

Connect the other end of the castor link to the arm frame "G" using the provided pin and hardware. *

* Does not apply to the FLX10.



2. Adjustments

Phasing the Yokes

To reduce noise and prevent accelerated wear, the flex arm gearbox yokes are set in phase. If replacement is required, ensure the yokes remain in phase.

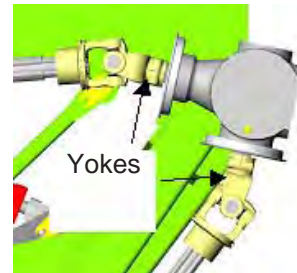

3. Setting the Castor Wheels

Castor cone spring tension nuts

Two back to back cone springs are used to keep the castor assemblies tight and reduce castor whipping action. The double jam nuts that are used to lock the castor assembly in place may need to be adjusted in order to take up wear in components of the castor pivot. The lower nut should be adjusted to the point that the cone springs are flattened, and then it should be backed off one half turn. Next, the lower nut should be held with a wrench so it does not change its position, while the upper nut is tightened down onto it.

4. Connection to Tractor

Adjust the drawbar length as recommended (540 or 1000 rpm). Adjust the height of the hitch clevis so that the frame is as level as possible. Pin clevis to the drawbar.

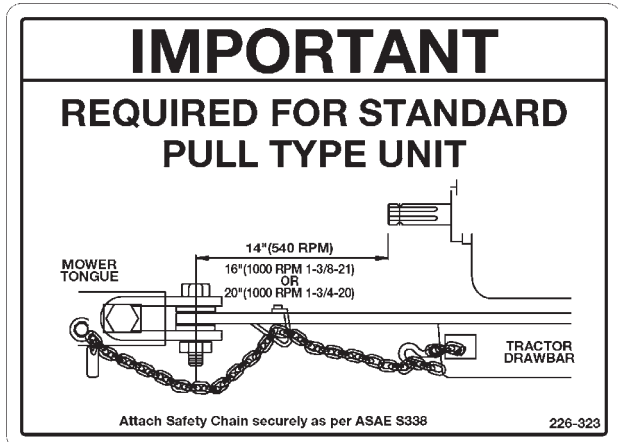

Connect the hoses to the remote outlets on the tractor. The hoses have a color-coded ties on both ends to easily identify them. Adjust the hoses in the hose organizer to allow sufficient slack for turning. Do not allow the hoses to contact the driveline or become pinched.

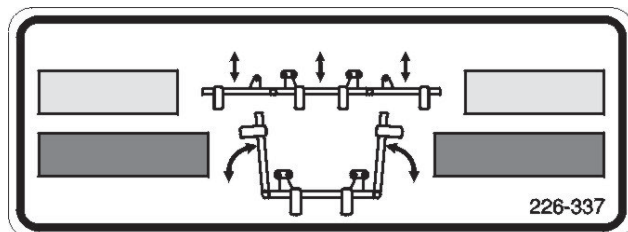

Move jack to its storage location on left wheel standard.
FLX15/10 04/06

Introduction Section 3-3

ASSEMBLY

Attach safety tow chain to flex arm and tractor. Fasten the large loop of the safety chain to the hitch, using the 1" bolt, washer, and nut. Attach the other end of the chain to tractor. Refer to your tractor operator's manual for complete instructions to attach chain to tractor. Adjust length to allow only enough slack as is needed for turning. Lock hook on chain. Ensure chain rating is equal to, or greater than the gross weight of the towed equipment.



WARNING! Do not use safety tow chain for towing. Replace entire chain if any link or end fitting is broken, stretched, or otherwise deformed.



Replace entire chain if any link or end fitting is broken, stretched, or otherwise deformed.

ASSEMBLY

5. DRIVELINE ATTACHMENT

The driveline yoke and tractor PTO shaft must be dirt free and greased for attachment.

1. Start by using the driveline that was shipped with the cutter being used. To connect the driveline to the tractor PTO output shaft, twist driveline yoke collar and align the grooves and splines of the yoke with those of the PTO shaft. Push the driveline yoke onto the PTO shaft, release the locking collar, and position the yoke until the locking collar balls are seated onto the PTO shaft. Push and pull the driveline back and forth several times to ensure a secure attachment.



2. Use the driveline that was shipped with the flex arm to connect to the flex arm and cutter. Connect the mower driveline to the gearbox output shaft, twist driveline yoke collar and align the grooves and splines of the yoke with those of the gearbox output shaft. Push the driveline yoke onto the output shaft, release the locking collar, and position the yoke until the locking collar balls are seated onto the output shaft. Push and pull the driveline back and forth several times to ensure a secure attachment.



IMPORTANT: DO NOT use a non-CV tractor shaft. Driveline damage will occur when turning the implement.

IMPORTANT: Do not operate the PTO with the flex arm in the transport position for extended periods of time. This may cause driveline vibration and will accelerate universal joint wear.

ASSEMBLY

WARNING!



When attaching the PTO yoke to the Tractor PTO shaft, it is important that the spring activated locking collar slides freely and the locking balls are seated securely in the groove of the PTO shaft. A driveline not attached correctly to the Tractor PTO shaft could slip off and result in personal injury and damage to the cutter.

Remove any tape from the splined shaft, and any booklets from the driveline. Install the shaft spacer (A101-157) onto the splined shaft tight against the steady bearing collar. Slide the clamp collar end of the tractor shaft onto the splined shaft and insert the tapered pin into the yoke. Push the yoke onto the shaft until the groove lines up with the hole and the pin extends through. Tighten the locknut to squeeze the yoke onto the shaft. The protective cone on the steady bearing may need to be unclipped to access the locknut.



6. Connection to Cutter

Remove the hitch clevis from the hitch swivel on the cutter if equipped. Insert the 3/4" bolts into the castor wheels to lock in place.

To align the precision hitch, board the tractor and start the engine. Back the tractor and FLEX-ARM to the cutter until arm hitch tongue is close enough to the cutter swivel. Then use the Flex Arm to extend the precision hitch tongue towards the cutter hitch swivel about a foot. Turn off the tractor engine, place the tractor in park, and set the parking brake before dismounting. Dismount and view to see how far is needed to go. Keep extending the flex arm in foot increments or as much length needed until holes are aligned. Once the cutter is connected remove the stabilizer bolts from the castor wheels to free the castor wheels. The stabilizer bolts are to be removed at all times except when backing the flex arm to connect the cutter. Castor wheels should not be left in the lock position after the cutter is attached, the stabilizer bolts are not transport pins, bodily injury or damage to the implement can result if left in.

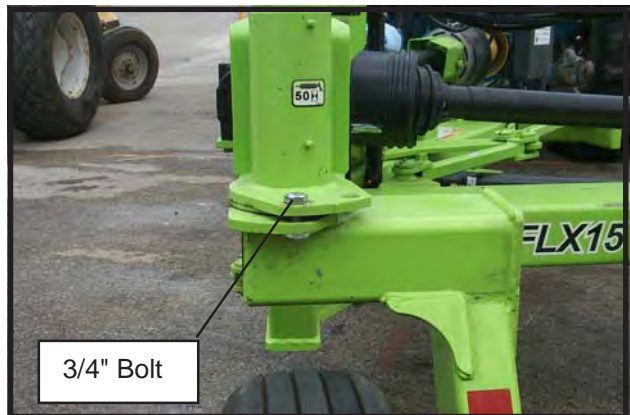

ASSEMBLY

DANGER!



Always shut the Tractor completely down, place the transmission in park, and set the parking brake before you or anyone else attempts to connect or disconnect the Implement and Tractor hitches. (S3PT-15)

Remove the cutter jack and place in its storage position.

7. Connecting Strut To Cutter

Pin the strut assembly to the mounting lugs on the arm and cutter with the 1" bolts. The length of the strut from pinpoint to pinpoint should be set to according to what type of cutter is being attached. See chart for length of strut according to cutter being used.

Machine	Strut length
XH1500	49-1/4"
XH1000	48-1/4"
S150	49"
S100	48"

NOTE: All cutters will have a strut mount lug welded to the cutter at the factory. If cutter is an older model and does not come with the welded mounted lug, a retro-fit weld on lug kit is available for purchase at your local dealer. The kit consist of lug, bolt & nut, a spray can paint, and installation instructions. Customer will be required to weld lug then drill a 17/32" hole through the tube and pin the safety bolt through it (the hole is already pre-drilled on the lug itself)

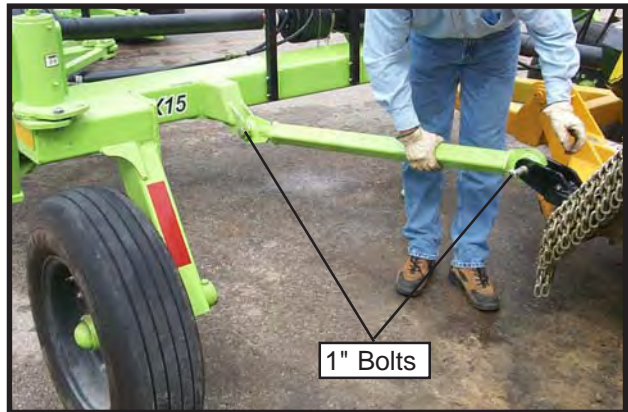

WARNING! NEVER STAND BETWEEN THE TRACTOR AND THE ROTARY CUTTER WHILE THE TRACTOR IS BEING BACKED TO THE HITCH



8. Connecting the Hoses to Breakaway Stand and Connecting the Selector Valve for 15' Models

Connect the cutter hoses to the hydraulic breakaway stand. The hoses are color coded to identify their location. Never leave a disconnected hose end open always keep them capped and clean from contamination.

Connect the driveline that was supplied with the Flex Arm and lower the PTO support.

IMPORTANT: Before operation remove the 3/4" bolts to unlock the castor wheels. To allow them to move freely.



The selector valve kit reduces the required tractor ports and provides independent double acting wing lift action.

DANGER!



Use wing lock up pins to secure wings or lower rotary cutter to the ground before attempting to connect the selector valve

ASSEMBLY

- On the rotary cutter wing lift cylinders, remove the breather plug from the clevis end and replace it with the supplied hose assembly. Install the hose with the double-wrapped blue ties on the right wing, and the double wrap orange ties on the left wing. Route both hoses through the hose organizers to the front of the cutter.

- Connect the rotary cutter hoses to the breakaway stand on the flex arm. The hoses are wrapped with color coding and/or ties for ease of assembly.

- The phasing circuit connects to the yellow marked hoses across the top of the breakaway stand.

- The right wing connects to the hoses marked with the blue ties. The single wrapped hose goes to the rod end of the right wing lift cylinder, and the hose with the double blue tie goes to the clevis end of the cylinder. Attach the blue coded hoses to the second row of connections on the breakaway stand with the single wrap blue on the right side

- The left wing connects to the hoses marked with the orange ties. The single wrapped hose connects to the rod end of the left wing lift cylinder, and the hose with the double orange tie goes to the clevis end of the cylinder. Attach the orange coded hoses to the third row of connections on the breakaway stand with the single wrap orange on the right side.

- The hoses are routed along the frame to the front of the flex arm.

- The yellow marked hoses connect to the tractor for the phasing lift system.

- The blue and orange marked hoses loop back and connect to the selector valve. The blue coded hoses to the right side of the selector valve, and the orange coded hoses to the left side of the selector valve. Single ties on the back port on each side, and double ties on the front ports of each side.

- The two hoses from the top of the selector valve connect to the tractor.

- A switch box installed in the cab of the tractor toggles the valve to operate the right wing or left wing.

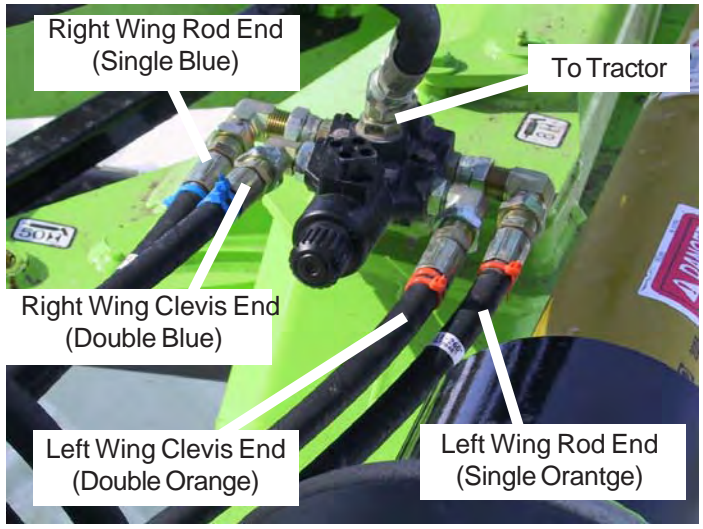
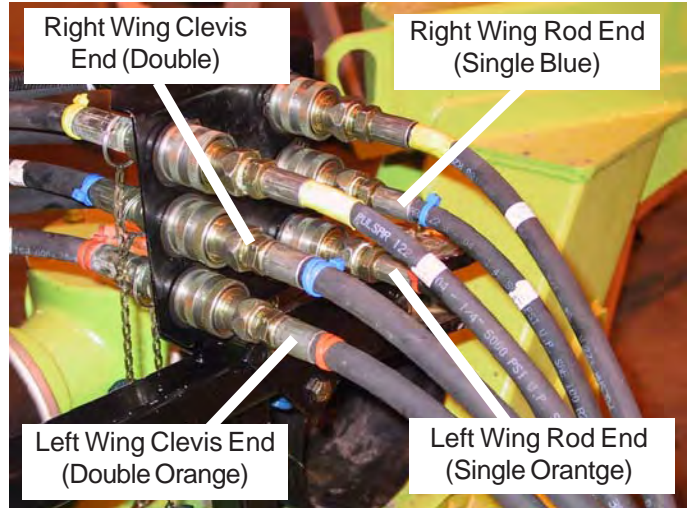

ASSEMBLY

9. Connecting the Hoses to Breakaway Stand and Connecting the Selector Valve for 10' Models

Connect the cutter hoses to the hydraulic breakaway stand. The hoses are color coded to identify their location. Never leave a disconnected hose end open always keep them capped and clean from contamination.

Connect the driveline that was supplied with the Flex Arm and lower the PTO support.

IMPORTANT: Before operation remove the 3/4" bolts to unlock the castor wheels. To allow them to move freely.

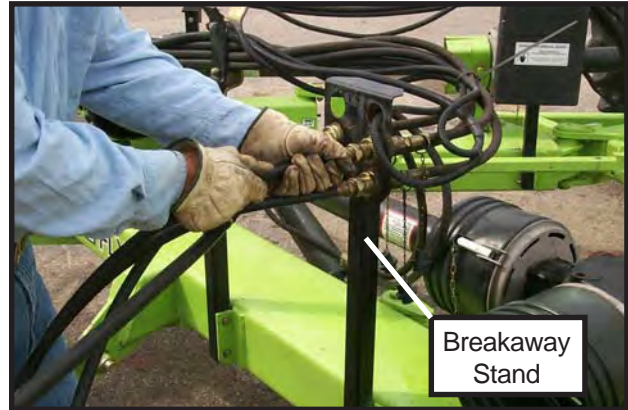

The selector valve kit reduces the required tractor ports and provides double acting wing lift action.

DANGER!

Use wing lock up pin to secure wing or lower rotary cutter to the ground before attempting to connect the selector valve



ASSEMBLY

ASSEMBLY

- On the rotary cutter wing lift cylinder, remove the breather plug from the clevis end and replace it with the supplied hose assembly. The replacement hose should have double-wrapped blue ties on the end. Route the hose through the hose organizers to the front of the cutter.
- Connect the rotary cutter hoses to the breakaway stand on the flex arm. The hoses are wrapped with color coding and/or ties for ease of assembly.
- The phasing circuit connects to the yellow marked hoses across the top of the breakaway stand.
- The wing connects to the hoses marked with the blue ties. The single wrapped hose goes to the rod end of the wing lift cylinder, and the hose with the double blue tie goes to the clevis end of the cylinder. Attach the blue coded hoses to the second row of connections on the breakaway stand with the single wrap blue on the right side. The bottom row of the breakaway stand will not be used.
- Route the hoses along the frame to the front of the flex arm and loop back to connect to the selector valve.
- Connect the blue coded hoses to the right side of the selector valve, and the yellow coded hoses to the left side of the selector valve.
- The two hoses from the top of the selector valve connect to the tractor. These hoses are coded with one yellow and one blue tie.
- A switch box installed in the cab of the tractor toggles the valve to operate the wing or phasing circuit.

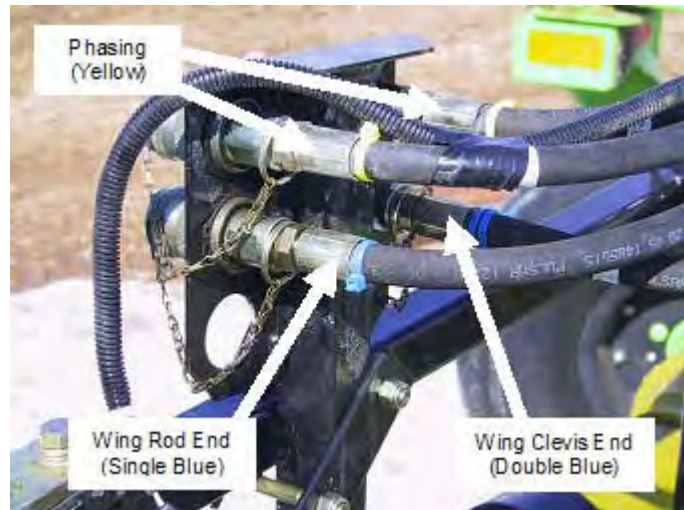

ASSEMBLY

10. General

IMPORTANT: Check oil level in all gearboxes before operation. Refer to the 'Lubrication' section of this manual for recommended oil type and viscosity.

Lubricate all grease fittings. Refer to the grease schedule in this manual.

Check that all nuts and bolts are in place and properly tightened. Refer to the 'Maintenance' section of this manual for required bolt grades and torques.

Check that all tires are inflated to proper specifications. Refer to the 'Maintenance' section of this manual for required tire pressures.

PRE CUSTOMER DELIVERY CHECKLIST

- | | |
|--|--------------------------|
| 1. Is oil level in the gearboxes to correct level? | <input type="checkbox"/> |
| 2. Has the proper oil been used in the Gearboxes? | <input type="checkbox"/> |
| 3. Are the Tires clear of the Mainframe, even when turning during axle articulation? | <input type="checkbox"/> |
| 4. Are all hoses tight and do not leak? | <input type="checkbox"/> |
| 5. Are all decals in place? See manual for decal description and placement. | <input type="checkbox"/> |
| 6. Does tractor pass Schulte Mower Stability Test? | <input type="checkbox"/> |
| 7. Are all bolts tight? | <input type="checkbox"/> |
| 8. Have all hoses been properly routed so that hoses do not kink or bind when arm is articulated through all motions? | <input type="checkbox"/> |
| 9. Is machine equipped with proper operator protection? ROPS Tractors Must have cage or cage panels. | <input type="checkbox"/> |
| 10. Does mower operate when on/off switch is on? Stop when switch is off? | <input type="checkbox"/> |
| 11. Is blade rotation correct? On the center section (looking from the top of the deck) rotation should be clockwise so that debris will be thrown away from the tractor | <input type="checkbox"/> |
| 12. Does mower operate smoothly at normal operating speed? Mower should not vibrate excessively. | <input type="checkbox"/> |

OPERATION SECTION

Operation Section 4-1

OPERATION

SCHULTE FLEX ARM 15/10 OPERATION INSTRUCTIONS

SCHULTE Flex Arms are manufactured with quality material by skilled workers. These arms are designed to allow the operator to travel on the road while the the 10' or 15' rotary cutter cuts the ditch slope. The rotary cutter is equipped with protective deflectors and/or chain guards to prevent objects being thrown from the mower by the blades, however, no shielding is 100% effective. All shields, guards, deflectors, and chains equipped on the unit must be maintained on the cutter in good operational condition.

It is the operator's responsibility to be knowledgeable of all potential operating hazards and to take every reasonable precaution to ensure oneself, others, animals, and property are not injured or damaged by the flex arm,mower, tractor, or a thrown object. Do not operate the flex arm and mower if passersby, pets, livestock, or property are within 300 feet of the unit.

This section of the Operator's Manual is designed to familiarize, instruct, and educate safe and proper mower use to the operator. Pictures contained in this section are intended to be used as a visual aid to assist in explaining the operation of a flex arm and flex-wing rotary cutter and are not necessarily of a flex arm and rotary cutter. Some pictures may show shields removed for picture clarity. NEVER OPERATE these implements without all shields in place and in good operational condition. The operator must be familiar with the flex arm,mower and tractor operation and all associated safety practices before operating the flex arm, mower and tractor. Proper operation of the flex arm and mower, as detailed in this manual, will help ensure years of safe and satisfactory use.

IMPORTANT: To avoid mower damage, retorque all bolts after the first 10 hours of operation.

FLEX ARM & MOWER STANDARD EQUIPMENT AND SPECIFICATIONS.....	4-4
(1) OPERATOR REQUIREMENTS.....	4-6
(2) TRACTOR REQUIREMENTS.....	4-7
(2.1) ROPS and Seatbelt.....	4-7
(2.2) Tractor Safety Devices.....	4-7
(2.3) Tractor Horsepower.....	4-8
(2.4) Drawbar.....	4-8
(2.5) Tractor Hydraulics.....	4-8
(2.6) Front End Weight.....	4-8
(2.7) Power Take Off (PTO).....	4-9
(2.8) Tire Spacing.....	4-9
(3) GETTING ON AND OFF THE TRACTOR.....	4-10
(3.1) Boarding the Tractor.....	4-10
(3.2) Dismounting the Tractor.....	4-10
(4) STARTING THE TRACTOR.....	4-11
(5) CONNECTING THE FLEX ARM TO THE TRACTOR.....	4-11
(5.1) Connecting theFlex Arm Tongue to the Tractor.....	4-12
(5.2) Connecting the Cutter Precision Hitch to the Flex Arm.....	4-13
(5.3) Connecting Mower Hydraulic Lines to the Tractor.....	4-14
(6) SETTING THE MOWER.....	4-15
(6.1) Setting Cutting Height.....	4-15
(6.2) Setting Deck Pitch.....	4-16

OPERATION

(7) DRIVELINE ATTACHMENT.....	4-16
(7.1) Constant Velocity (CV) Driveline.....	4-17
(7.2) Lighting Kit Relocated	4-18
(8) PRE-OPERATION INSPECTION AND SERVICE.....	4-18
(8.1) Tractor Pre-Operation Inspection/Service.....	4-19
(8.2) Mower Pre-Operation Inspection/Service.....	4-19
(8.3) Cutting Component Inspection.....	4-22
(9) DRIVING THE TRACTOR AND MOWER.....	4-23
(9.1) Starting the Tractor.....	4-24
(9.2) Brake and Differential Lock Setting.....	4-24
(9.3) Operating the Mower Wings.....	4-24
(9.4) Driving the Tractor, Flex Arm, and Mower.....	4-26
(9.5) Crossing Ditches and Steep Inclines.....	4-27
(10) OPERATING THE TRACTOR, FLEX ARM, AND MOWER.....	4-28
(10.1) Foreign Debris Hazards.....	4-28
(10.2) Bystander/Passersby Precaution.....	4-29
(10.3) Engaging the Power Take Off (PTO).....	4-30
(10.4) PTO RPM and Ground Speed.....	4-30
(10.5) Operating the Flex Arm & Mower.....	4-31
(10.6) Shutting Down the Mower.....	4-34
(11) DISCONNECTING THE FLEX ARM & MOWER FROM THE TRACTOR.....	4-34
(12) FLEX ARM & MOWER STORAGE.....	4-35
(13) TRANSPORTING THE TRACTOR, FLEX ARM, AND MOWER.....	4-36
(13.1) Transporting on Public Roadways.....	4-38
(13.2) Hauling the Tractor, Flex Arm, and Mower.....	4-41
(14) TROUBLE SHOOTING GUIDE.....	4-43

OPERATION

READ AND UNDERSTAND THE ENTIRE OPERATING INSTRUCTIONS AND SAFETY SECTION OF THIS MANUAL AND THE TRACTOR MANUAL BEFORE ATTEMPTING TO USE THE TRACTOR AND MOWER. If you do not understand any of the instructions, contact your nearest authorized dealer for a full explanation. Pay close attention to all safety signs and safety messages contained in this manual and those affixed to the cutter and tractor.

DANGER!



READ, UNDERSTAND, and FOLLOW the following Safety Messages. Serious injury or death may occur unless care is taken to follow the warnings and instructions stated in the Safety Messages. Always use good common sense to avoid hazards. (SG-2)

SAFETY INSTRUCTIONS



PELIGRO!



Si no lee Ingles, pida ayuda a alguien que si lo lea para que le traduzca las medias de seguridad. (SG-3)

!LEA EL INSTRUCTIVO!



OPERATION

Flex-Arm Equipment And Specifications

	FLX15	FLX10
Transport Width	131"(3.327 m)	113"(2.870 m)
Transport Width with Cutter	135"(3.429 m)	116"(2.947 m)
Transport Length	174"(4.420 m)	176"(4.47 m)
Transport Length with Cutter	299"(7.596 m)	299"(7.596 m)
Approximate Weight	1850 lbs.(839 kg)	1650 lbs.(748 kg)
Swing Range	87"(2.210 m)	75"(1.905 m)
Hitch Load	275 lbs.(125 kg)	300 lbs.(125 kg)
Recommended Tractor HP	85 HP (65 kW)	75 HP (55 kW)
Ground Clearance	12" (305 mm)	12" (305 mm)
Minimum Tractor Hydraulics	1 single acting remote, 2 double acting remotes @ 1750 psi	1 single acting remote, 2 double acting remotes @ 1750 psi
*Recommended Tractor Hydraulics	4 double acting remotes @ 1750 psi	3 double acting remotes @ 1750 psi

* If your tractor isn't equipped with enough remotes or if you would like independent wing lift, a selector valve kit can be purchased.

Mower Standard Equipment And Specifications

	XH1500	XH1000
Cutting width	180"(4.572m)	126" (4.572m)
Overall width	190" (4.826m)	136" (4.826m)
Overall Length	189" (4.800m)	189" (4.800m)
Trans. Width Below Tires	96" (2.438m)	90" (2.438m)
Transport Height Deck	84" (2.134m)	84" (2.134m)
Thickness Approximate	7GA (3/16") (5mm) 4800	7GA (3/16") (5mm) 4200
Weight Minimum Tractor HP	lbs (2182kg) 65 HP	lbs (2182kg)
Recommended Tractor HP	(50kw) 85 HP (6Skw)	50 HP (40kw) 75 HP (S5kw)
Cutting Height	1 1/2" - 15" (38mm -381mm)	1 1/2" -15" (38mm -381mm)
Ground Clearance Cutting	13 1/2" (343mm)	13 1/2" (343mm)
Capacity Blade Overlap	4" material (102mm)	4" material (102mm)
Divider Gearbox Rating	6 1/2" (165mm)	6 1/2" (165mm)
Center/Wing Gearbox Rating	200HP (160kw)	200HP (160kw)
Blade Speed, 540 rpm	160 HP (128kw)	160HP(128kw)
Centre (8/Orprn)		
Wing (940rpm) Blade	15,268ft/min (4654m/min)	15,268ft/min (4654m/min)
Speed, 1000 rpm	14,765ft/min (4500m/min)	14,765ft/min (4500m/min)
Centre (800rpm)		
Wing (9S4rpm) Wing	15,079ft/min (4596m/min)	15,079ft/min (4596m/min)
Working Range	14,985ft/min (4567m/min)	14,985ft/min (4567m/min)
	25° down to 85° up	25° down to 85° up

OPERATION

OPERATION

	S150	S100
Cutting Width	180" (4.57)	126"(3.20 m)
Overall Width	190"(4.82 m)	136"(3.45 m)
Overall Length	196"(4.97 m)	196"(4.97 m)
Transport width below wing tires	96"(2.43 m)	90"(2.28 m)
Transport Height	84"(2.13 m)	84"(2.13 m)
Deck thickness	7 ga(3/16")	7 ga(3/16")
Approximate weight	4400 lbs.(2000 kg)	4200 lbs.(1909 kg)
Minimum Tractor HP	65 HP (50 kW)	50 HP (40 kW)
Recommended Tractor HP	85 HP (65 kW)	75 HP (55 kW)
Cutting Height	1.5"-15" (38 mm - 381 mm))	
Ground clearance	13.5" (343 mm)	
Cutting capacity	2" material (50 mm)	
Blade Overlap	6" (153" mm)	
Divider gearbox rating	160 HP (120 kW)	
Wing gearbox rating	110 HP (85 kW)	
Center wing	810 RPM-15,268 ft/min	
Blade speed, 1000 rpm	940 RPM-15,458 ft/min	
Center wing	800 RPM-15,702 ft/min(4786 m/mm)	
Blade speed, 1000 rpm	1000 RPM-15,708 ft/min(4789 m/mm)	
Wing working range	24° down to 85° up	

General Data	ST15	ST10
Cutting width:	180"	126"
Overall width:	190"	136"
Overall length:	196"	196"
Transport width below wing tires:	96"	90"
Transport height:	84"	84"
Approximate weight, with all options:	4400 lbs	4200 lbs
Hitch load, transport:	1500 lbs	1360 lbs
Cutting height:	1-1/2" - 15"	
Ground clearance, transport:	13-1/2"	
Cutting capacity:	2" material	
Minimum tractor HP:	65 HP	50 HP
Recommended tractor HP:	85 HP	75 HP
Tractor hydraulics, minimum:	3 single acting circuits @ 1750 psi	
Tractor hydraulics, phasing:	1 double acting circuit @ 1750 psi 2 single acting circuits @ 1750 psi	
Blade speed, 540 rpm	Center: 810 rpm	15,268 ft/min tip speed
	Wing: 984 rpm	15,457 ft/min tip speed
Blade speed, 1000 rpm	Center: 800 rpm	15,702 ft/min tip speed
	Wing: 1000 rpm	15,708 ft/min tip speed
Working range of wings:	24° down to 85° up	
Blade overlap:	6"	[153 mm]

OPERATION

DANGER!



The Mower is designed for certain mowing applications and is rated to cut up to a specific size vegetation (see Mower Standard Equipment and Specifications). **DO NOT** use this Mower to cut vegetation above the Mower's rated capacity or to cut any type of non-vegetative material. Only operate this Mower on a properly sized and equipped Tractor. Operating this Mower in an application for which it is not designed and/or operating the Mower with the wrong size Tractor can cause Mower component damage and equipment failure resulting in possible serious injury or death. (SGM-14)

Note: The mower must be equipped with either single or double chain guards at all times. Schulte recommends mowers be equipped with double chain guards for all mowing purposes. Single chain guards may be used for agriculture purposes only and are specifically not recommended for highway, right-of-way, parks or greenbelt mowing.

1. OPERATOR REQUIREMENTS

Safe operation of the rotary mower is the responsibility of a qualified operator. A qualified operator has read and understands both the mower and tractor Operator Manuals and is experienced in tractor and mower operations and all associated safety practices. In addition to the safety messages contained in this manual, safety message decals are affixed to the mower and tractor. If any part of the operation and safe use of the mower and tractor is not completely understood, consult an authorized dealer for a full explanation.

Safe mower operation requires that the operator wear approved Personal Protective Equipment (PPE) for the job conditions while connecting, operating, servicing and repairing the mower and tractor. PPE is designed to provide operator protection from bodily injury and includes the following:

OPERATION

Personal Protective Equipment (PPE)

- Protective eye glasses, goggles, or face shield
- Hard hat
- Steel toed safety footwear
- Gloves
- Hearing protection
- Close fitting clothing
- Respirator or filter mask



DANGER!



NEVER use drugs or alcohol immediately before or while operating the Tractor and Implement. Drugs and alcohol will affect an operator's alertness and coordination and therefore affect the operator's ability to operate the Equipment safely. Before operating the Tractor or Implement, an operator on prescription or over-the-counter medication must consult a medical professional regarding any side effects of the medication that would hinder their ability to operate the Equipment safely. **NEVER** knowingly allow anyone to operate this Equipment when their alertness or coordination is impaired. Serious injury or death to the operator or others could result if the operator is under the influence of drugs or alcohol. (SG-27)



OPERATION

2. TRACTOR REQUIREMENTS

The tractor used to operate the mower must have the power capacity to lift, pull, and operate the Power Take Off (PTO) at the mower's rated speed while traveling at a ground speed between 2 and 5 MPH. Operating the mower with a tractor that does not meet the following requirements may cause tractor or mower damage and be a potential danger to the operator and passersby.

Tractor Requirements and Capabilities

- ASAE approved Roll-Over Protective Structure (ROPS) or ROPS cab and seat belt.
- Tractor Safety Devices..... Slow Moving Vehicle (SMV) emblem, lighting, PTO master shield
- Tractor Horsepower - Recommended..... FLX15, 85 HP; FLX10, 75 HP
- Drawbar..... Set length according to operating speed and driveline type, rated to carry weight of the mower, safety chain attachment point
- Hydraulics
 - Minimum..... 1 single acting remote, 2 double acting remotes @ 1750psi
 - Phasing..... 4 double acting remotes @ 1750 psi (FLX15), 3 double acting remotes @ 1750 psi (FLX10)
- Front End Weights..... As needed to maintain 20% weight on front axle
- Power Take Off..... Operating speed and shaft size depends on operating speed and driveline type of the mower.
- Tire Spacing..... Set tires minimum width of 60" inside to inside of tires.

2.1 ROPS and Seat Belt

A Roll-Over-Protective-Structure (ROPS) and seat belt are essential to protect the operator from falling off the tractor, especially during a roll over where the driver could be crushed and killed. The ROPS and seat belt must be used in conjunction with one another. Only operate the tractor with the ROPS in the raised position and seat belt fastened. Tractor models not equipped with a ROPS and seat belt should have these life saving features installed by an authorized tractor dealer.

WARNING!



Operate this Equipment only with a Tractor equipped with an approved roll-over-protective system (ROPS). Always wear seat belts. Serious injury or even death could result from falling off the Tractor--particularly during a turnover when the operator could be pinned under the ROPS. (SG-7)



2.2 Tractor Safety Devices

If transporting or operating the tractor and mower near a public roadway, the tractor must be equipped with proper warning lighting and a Slow Moving Vehicle (SMV) emblem which are clearly visible from the rear of the unit. Lights and a SMV emblem must be equipped directly on implements if the visibility of the tractor warning signals are obscured.

Maintain all manufacturer equipped safety shields and guards. Always replace shields and guards that were removed for access to connect, service, or repair the tractor or mower. Never operate the tractor PTO with the PTO master shield missing or in the raised position.

OPERATION

2.3 Tractor Horsepower

The horsepower required to operate the mower depends on several operating factors including the vegetation to be cut, terrain condition, operator experience, condition of the mower and tractor, and other factors. The recommended tractor HP for the FLX15 is 85 HP. The recommended tractor HP for the FLX10 is 75 HP. The recommended tractor HP for the S150 is 85 HP and S100 is 75 HP. Operating the mower with a tractor that does not have enough power will produce a less desirable cut and may cause tractor engine damage.

2.4 Drawbar

Position the length of the drawbar from the end of the tractor PTO shaft to the drawbar hitch hole according to the operating speed of the mower. If the mower is a 540 RPM unit, position the drawbar length from shaft end to hitch hole at 14". For 1000 RPM mowers, set the drawbar length at 16" for 21 spline 1-3/8" mowers and at 20" for 1-3/4" 20 spline mowers.

Tractor Drawbar Length (Based on Mower Operating Speed)

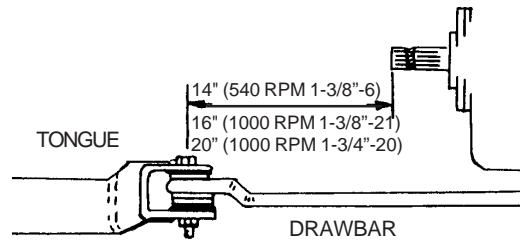

2.5 Tractor Hydraulics

The mower deck and wings are raised and lowered with hydraulic cylinders operated by the tractor hydraulic pump. There are several ways to configure the mower hydraulics depending on the number of tractor selective control valves and if they are four double acting. The mower can be operated on a tractor with a minimum of four single acting circuits. One double acting and two single acting cylinders or a three spool control valve must be used to operate the mower equipped with hydraulic phasing cylinders.

Refer to the assembly and parts section of this manual for hydraulic system set-up or contact an authorized dealer for the best configuration depending on your tractor hydraulic capabilities and your intended mower use.

2.6 Front End Weight

A minimum of 20% total tractor weight must be maintained on the tractor front end at all times. Front end weight is critical to maintain steering control and to prevent the tractor from rearing up while driving. If the front end is too light, add weight until a minimum of 20% total weight is reached on the front tires. Front weights and weight carriers can be purchased through an authorized tractor dealership.

OPERATION

2.7 Power Take Off (PTO)

Depending on the unit, the mower is designed to operate at a PTO speed of 540 or 1000 RPM. Most tractors operate at either 540, or a combination of 540 and 1000 RPM PTO speeds. The operating speed of the mower and tractor can be determined by the number of splines on the driveline yoke and PTO output shaft. Those operating at 540 RPM will have a 1-3/8" diameter 6-spline shaft and those operating at 1000 RPM will have a 1-3/8" 21-spline shaft or a 1-3/4" 20 spline shaft. Refer to the tractor owner's manual for instructions to change PTO speeds on models that operate at more than one speed.

If operating an older model tractor where the tractor's transmission and PTO utilize one master clutch, an over-running clutch must be used between the PTO output shaft and the driveline of the mower. An authorized tractor dealer can provide the over-running clutch and its installation if needed.

WARNING!



DO NOT use a PTO adapter to attach a non-matching Implement driveline to a Tractor PTO. Use of an adapter can double the operating speed of the Mower resulting in excessive vibration, thrown objects, and blade and mower failure. Adapter use will also change the working length of the driveline exposing unshielded driveline areas. Serious bodily injury and/or equipment failure can result from using a PTO adapter. Consult an authorized dealer for assistance if the Implement driveline does not match the Tractor PTO.

(S3PT-14)

WARNING!



Never operate the Tractor and Mower if the Mower main driveline is directly connected to the Tractor transmission. Tractor braking distances can be substantially increased by the momentum of the rotating Mower blades driving the Tractor transmission even though the Tractor clutch has been engaged. Install an over running clutch between the Tractor PTO and the Mower driveline to prevent this potentially dangerous situation.

2.8 Tire Spacing

Tractor tires should be set a minimum of 60" apart measured from inside of tire to inside of tire. Refer to the tractor Operator's Manual or consult an authorized dealer for instructions to change tractor tire spacing.



OPERATION

3. GETTING ON AND OFF THE TRACTOR

Before getting onto the tractor, the operator must read and completely understand the mower and tractor operator manuals. If any part of either manual is not completely understood, consult an authorized dealer for a complete explanation.

WARNING!



Do not mount the Tractor while the tractor is moving. Mount the Tractor only when the Tractor and all moving parts are completely stopped. (SG-12)



3.1 Boarding the Tractor

Use both hands and equipped handrails and steps for support when getting on the tractor. Never use tractor control levers for support when mounting the tractor. Always seat yourself in the operator's seat and fasten the seatbelt. Only operate the tractor and mower with the ROPS in the raised position.

Never allow passengers to ride on the tractor or mower. Riders can easily fall off and be seriously injured or killed from being ran over by both the tractor and mower. It is the operator's responsibility to forbid riders.

DANGER!



Never allow children or other persons to ride on the Tractor or Implement. Falling off can result in serious injury or death. (SG-10)



DANGER!



Never allow children to operate or ride on the Tractor or Implement. (SG-11)



OPERATION

3.2 Dismounting the Tractor

Before dismounting, park the tractor and mower on a reasonably level surface, apply the parking brake, idle the engine down, disengage the PTO, and lower the mower to the ground. Shut down the tractor engine according to the operator's manual, remove the key, and wait for all motion to completely stop. Never leave the seat until the tractor, its engine and all moving mower parts are completely stopped.

DANGER!



BEFORE leaving the Tractor seat, always engage the brake and/or set the Tractor transmission in parking gear, disengage the PTO, stop the engine, remove the key, and wait for all moving parts to stop. Place the Tractor shift lever into a low range or parking gear to prevent the Tractor from rolling. Never dismount a Tractor while it is moving or while the engine is running. Operate the Tractor controls from the Tractor seat only. (SG-9)

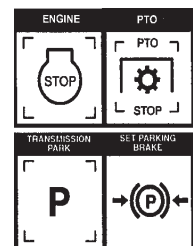

Use hand rails and steps when exiting the tractor. Be careful of your step and use extra caution when mud, ice, snow or other matter has accumulated on the steps or hand rails. Use all handrails and steps for support and never rush or jump off the tractor.

OPERATION

4. STARTING THE TRACTOR

The operator must have a complete understanding of the placement, function, and operational use of all tractor controls before starting the tractor. Review the tractor operator's manual and consult an authorized dealer for tractor operation instructions if needed.

Essential Tractor Controls:

- Locate the light control lever
- Locate the engine shut off control
- Locate the brake pedals and the clutch
- Locate the PTO control
- Locate the 3 point hitch control lever
- Locate the hydraulic remote control levers

Before starting the tractor ensure the following:

- Conduct all pre-start operation inspection and service according to the tractor operator's manual.
- Make sure all guards, shields, and other safety devices are securely in place.
- The parking brake is on.
- The PTO control lever is disengaged.
- The 3-point hitch control lever is in the lowered position.
- The hydraulic remote control levers are in the neutral position.
- The tractor transmission levers are in park or neutral.

Refer to the tractor owner's manual for tractor starting procedures. Only start the tractor while seated and belted in the tractor operator's seat. Never bypass the ignition switch by short circuiting the starter solenoid.

After the tractor engine is running, avoid accidental contact with the tractor transmission to prevent sudden and unexpected tractor movement.

DANGER!



Never run the Tractor engine in a closed building or without adequate ventilation. The exhaust fumes can be hazardous to your health. (SG-23)

DANGER!



Start the Tractor only when properly seated in the Tractor seat. Starting a Tractor in gear can result in injury or death. Read the Tractor operator's manual for proper starting instructions. (SG-13)



5. CONNECTING THE FLEX-ARM TO THE TRACTOR

Use extreme caution when connecting the FLEX-ARM to the tractor. The FLEX-ARM should be securely resting at ground level with the parking jack foot. Place a block in front of and behind wheels to prevent the FLEX-ARM from moving. Keep hands and feet out from under the FLEX-ARM and clear of pinch points between the tractor and FLEX-ARM.

DANGER!



Always shut the Tractor completely down, place the transmission in park, and set the parking brake before you or anyone else attempts to connect or disconnect the Implement and Tractor hitches. (S3PT-15)

OPERATION

5.1 Connecting the FLEX-ARM Tongue to the Tractor

1. Ensure the tractor is equipped with the correct PTO shaft and the drawbar is set at the correct length.
2. Using the parking jack, position the tongue clevis to the height of the tractor drawbar.
3. Board the tractor and start the engine. Back the tractor to the FLEX-ARM aligning the drawbar hitch hole with the FLEX-ARM tongue clevis. Turn off the tractor engine, place the tractor in park, and set the parking brake before dismounting.

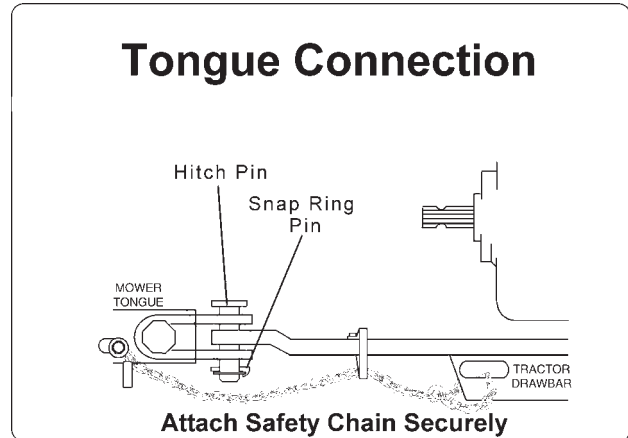

DANGER!



Always shut the Tractor completely down, place the transmission in park, and set the parking brake before you or anyone else attempts to connect or disconnect the Implement and Tractor hitches. (S3PT-15)

4. To attach the Flex Arm insert the hitch pin through the drawbar and tongue clevis. Once the pin is inserted, attach the snap ring pin through the hole on the hitch pin and snap in place.
5. Attach safety tow chain to flex arm and tractor. Fasten the large loop of the safety chain to the hitch, using the 1" bolt, washer, and nut. Attach the other end of the chain to tractor. Refer to your tractor operator's manual for complete instructions to attach chain to tractor. Adjust length to allow only enough slack as is needed for turning. Lock hook on chain. Ensure chain rating is equal to, or greater than the gross weight of the towed equipment.
6. Lower the jack until the tongue is completely supported by the drawbar. Remove jack from the tongue and place on storage bracket of FLEX-ARM.



Safety Tow Chain

If the FLEX-ARM is towed on a public roadway, a safety chain with tensile strength equal to or greater than the gross weight of the FLEX-ARM & mower must be connected between the tractor and FLEX-ARM. This will help control the implement in the event the tongue becomes disconnected from the drawbar. After connecting both ends of the safety chain, drive the tractor to the right and left to check for proper chain length. Adjust length as necessary and allow only enough slack in the chain to make a maximum turn in both directions.

OPERATION

5.2 Connecting the Cutter Precision Hitch to the FLEX-ARM

1. Ensure the FLEX-ARM is equipped with the correct gearbox output shaft.
2. Using the parking jack, position the cutter tongue clevis to the height of the FLEX-ARM precision hitch.
3. Insert the 3/4" bolts into the castor wheels to lock them into place when backing up.

IMPORTANT: Castor Wheel stabilizer pins need to be inserted in the castor wheels when backing the flex arm up to connect the mower. All other times pins should not be in castor wheels.

4. To align the precision hitch, board the tractor and start the engine. Back the tractor and FLEX-ARM to the cutter until arm hitch tongue is close enough to the cutter swivel. Then use the Flex Arm to extend the precision hitch tongue towards the cutter hitch swivel about a foot. Turn off the tractor engine, place the tractor in park, and set the parking brake before dismounting. Dismount and view to see how far is needed to go. Keep extending the flex arm in foot increments or as much length needed until holes are aligned.



DANGER!



Always shut the Tractor completely down, place the transmission in park, and set the parking brake before you or anyone else attempts to connect or disconnect the Implement and Tractor hitches. (S3PT-15)

5. To attach the mower, place the cutter hitch pin through the hitch clevis and hitch tongue. Insert the 1/2" bolt, lockwasher, and flatwasher to the pin and hitch clevis. This keeps the pin in place and does not allow it to rotate. Attach the bushing to the bottom of the pin and insert the roll pin to the pin. Be sure the bolt is tightened but do not over tighten. NEVER attach the mower to the tractor without the bolt or roll pin attached to the retaining pin .

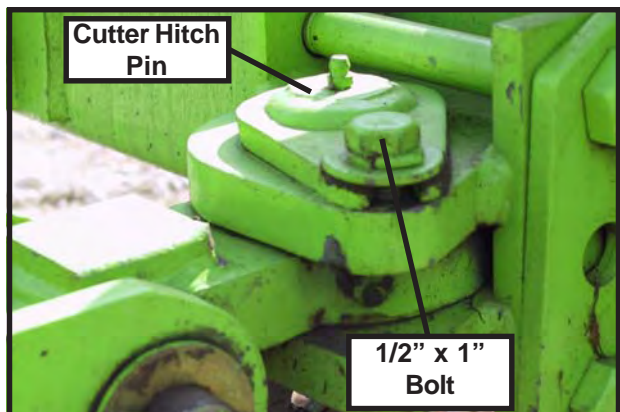

OPERATION

- Securely attach the flex arm safety chain to the mowers a-frame. Ensure the FLEX-ARM end is securely attached through the Safety Chain Attachment Location and is securely wrapped around the mower "A" frame.
- Lower the jack until the tongue is completely supported by the drawbar. Remove jack from the tongue and place on storage bracket of mower.

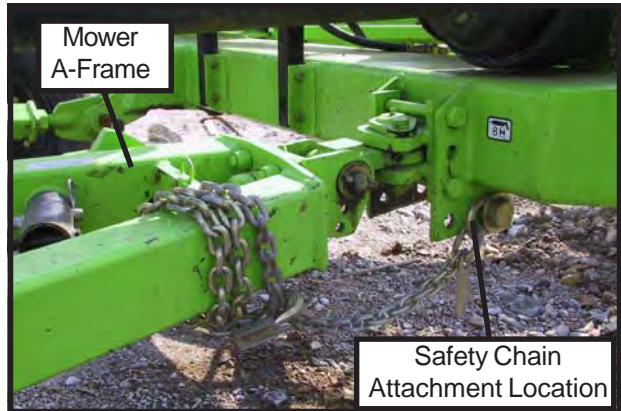

- Pin the strut assembly to the mounting lugs on the arm and cutter with 1" bolts the length of the strut from pinpoint to pinpoint should be set according to chart below.

Machine	Strut length
XH1500	49-1/4"
XH1000	48-1/4"
S150	49"
S100	48"

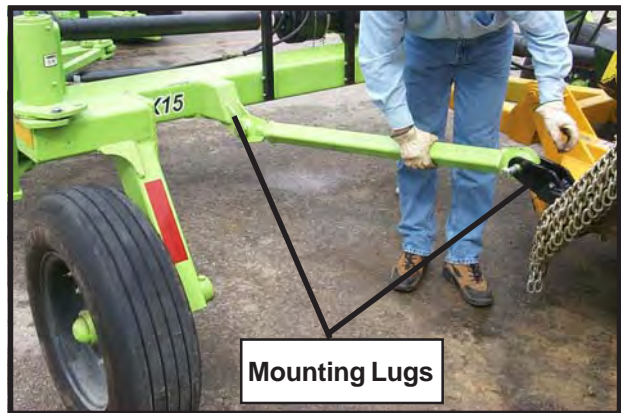

NOTE: All cutters will have a strut mount lug welded to the cutter at the factory. If cutter is an older model and does not come with the welded mounted lug, a retro-fit weld on lug kit is available for purchase at your local dealer. The kit consists of lug, bolt & nut, a spray can or paint, and installation instructions. Customer will be required to weld lug then drill a 17/32" hole through the tube and pin the safety bolt through it (the hole is already pre-drilled on the lug itself)

5.3 Connecting Mower Hydraulic Lines to the Tractor

With the tractor shut down and secured in position, relieve hydraulic pressure from the tractor by moving the control levers back and forth several times or placing the levers in the float position. Keep mower hydraulic lines, hoses, quick couplers, and swivels free of contamination. Never leave a disconnected hose end open and cap the tractor hydraulic outlet ports when not in use. If the tractor ports, Flex-Arm ports, or mower hydraulic hose ends become contaminated, wipe clean with a rag before connecting.

DANGER!



Do not operate this Equipment with hydraulic oil leaking. Oil is expensive and its presence could present a hazard. Do not check for leaks with your hand! Use a piece of heavy paper or cardboard. High-pressure oil streams from breaks in the line could penetrate the skin and cause tissue damage including gangrene. If oil does penetrate the skin, have the injury treated immediately by a physician knowledgeable and skilled in this procedure. (SG-15)



OPERATION

FLX15 Hydraulic Circuit Requirements

Hoses and breakaways are provided in order to connect to a 15' rotary cutter with individual single acting wing circuits. A total of 4 hydraulic circuits are required. Two of the circuits require float positions on the control valves in order to operate the single acting wing circuits on the rotary cutter.

FLX10 Hydraulic Circuit Requirements

Hoses and breakaways are provided in order to connect to a 10' rotary cutter with single acting wing circuit. A total of 3 hydraulic circuits are required. One of the circuits requires a float position on the control valve in order to operate the single acting wing circuit of the rotary cutter.

Hydraulic Line Support

After connecting the Flex-Arm hydraulic lines to the tractor, and mower hydraulics to the Flex-Arm, support the hoses with the equipped brackets. Ensure that hoses do not contact the driveline, do not bind while turning, and do not become pinched or kinked.

Hydraulic Cylinder Priming

Hydraulic Cylinders must be filled with hydraulic oil before removing the wing transport pins to lower the mower wings and deck. Hydraulic cylinders and lines are filled by holding the valve control levers in the raised position until the cylinders fully retract (wing cylinders) and extend (center cylinder). Place control levers in the float position and repeat process several more times to purge all air from the system. Ensure wings are entirely supported by the cylinders before removing the transport pins. NEVER drive out pins and NEVER remove transport pins that have tension on them.

6. SETTING THE MOWER

Properly setting the cutting height is essential for efficient and safe operation. A properly set mower will make a more uniform cut, distribute clippings more evenly, require minimal tractor work, and follow the contour of uneven terrain. Note: Avoid very low cutting heights, striking the ground with the blades gives the most damaging shock loads and will cause damage to the mower and drive. Blades contacting the ground may cause objects to be thrown out from under the mower deck. Always avoid operating the mower at a height which causes the blades to contact the ground.

DANGER!



Never work under the Implement, the framework, or any lifted component unless the Implement is securely supported or blocked up to prevent sudden or inadvertent falling which could cause serious injury or even death. (SG-14)



OPERATION

6.1 SETTING CUTTING HEIGHT

The cut height for the center section is set by extending or shortening the depth collar located on the center lift cylinder. Cutting height for the wing cylinders will be automatically controlled by the hydraulic phasing system. Depth stops are also provided on the wing cylinders as back up for fine adjustments.

IMPORTANT: If depth control stops are not set at the same height as the center cylinder, internal damage may occur to the phasing cylinders.

The cutter should always be operated in the highest position that will produce the desired cutting results. Operating at increased heights will minimize the chances of blades contacting the ground and discharging debris.

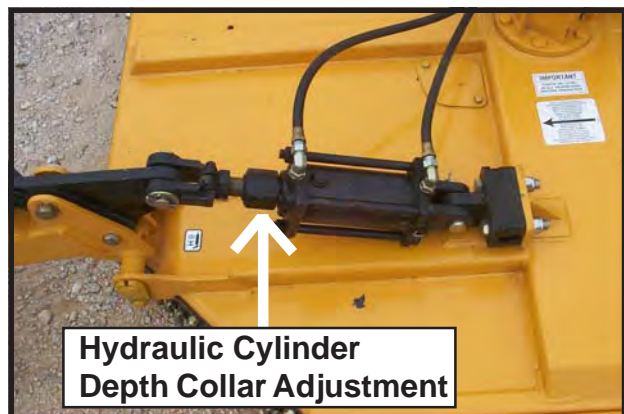

OPERATION

6.2 Setting Deck Pitch

To facilitate safe and efficient operation, the mower should be operated with the deck approximately 3/4" LOWER IN THE REAR THAN THE FRONT.

Operating the mower with the rear of the deck slightly lower than the front provides better suction, lifting the grass and creating a clean cut with less windrowing. For heavier applications, the front of the mower may need to be raised an additional 1/2" - 1".

Adjust the lift rods linking the tongue to the rear axle until mower is at least 3/4" lower in the rear than the front. To lower the front, lengthen the lift rods and to raise the front shorten the rods. **IMPORTANT:** Adjust the lift rods the same amount and maintain equal tension in the rods. Improper adjustment may cause rods to snap or bend. Retighten the jamnuts after the deck pitch has been set.

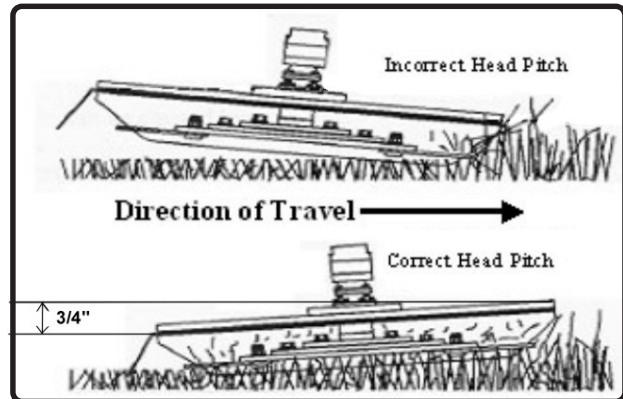

7. DRIVELINE ATTACHMENT

The driveline yoke and tractor PTO shaft must be dirt free and greased for attachment.

1. Start by using the driveline that was shipped with the cutter being used. To connect the driveline to the tractor PTO output shaft, twist driveline yoke collar and align the grooves and splines of the yoke with those of the PTO shaft. Push the driveline yoke onto the PTO shaft, release the locking collar, and position the yoke until the locking collar balls are seated onto the PTO shaft. Push and pull the driveline back and forth several times to ensure a secure attachment.



2. Use the driveline that was shipped with the flex arm to connect to the flexarm and cutter. Connect the mower driveline to the gearbox output shaft, twist driveline yoke collar and align the grooves and splines of the yoke with those of the gearbox output shaft. Push the driveline yoke onto the output shaft, release the locking collar, and position the yoke until the locking collar balls are seated onto the output shaft. Push and pull the driveline back and forth several times to ensure a secure attachment.



OPERATION

IMPORTANT: DO NOT use a non-CV tractor shaft. Driveline damage will occur when turning the implement.

IMPORTANT: Do not operate the PTO with the flex arm in the transport position for extended periods of time. This may cause driveline vibration and will accelerate universal joint wear.

WARNING!



When attaching the PTO yoke to the Tractor PTO shaft, it is important that the spring activated locking collar slides freely and the locking balls are seated securely in the groove of the PTO shaft. A driveline not attached correctly to the Tractor PTO shaft could slip off and result in personal injury and damage to the cutter.

7.1 Constant Velocity (CV) Driveline

For mowers equipped with a Constant Velocity (CV) driveline, the maximum turning angle between the tractor and mower must be determined to ensure the joint angle does not over-extend which can cause CV joint damage. Constant Velocity joints enable the driveline to operate smoothly with no vibrations and clattering at angles up to 70°. Angles greater than 80° can result in mechanical damage to the CV joint and mower driveline.

The Constant Velocity joint must be lubricated every 8 hours of operation as specified in the Maintenance Section. Failure to properly lubricate the joint will result in accelerated wear and joint component failure.

CV Driveline Maximum Angle Check Procedure

1. With the **mower attached** to the tractor and the **driveline disconnected** from the tractor PTO stub make a hard left turn until there is approximately a 1" clearance between the left rear tractor tire and mower frame or tongue.
2. Stop and completely shut down the tractor. Place the tractor in Park and apply the Parking Brake before dismounting.
3. Check the CV joint at this maximum turning radius by holding the driveline yoke above the PTO shaft and then angle the CV joint to its maximum angle. A minimum difference of 10 degrees between the center line of the yoke and the PTO shaft must be maintained to ensure the joint will not be over angled. If the joint cannot be angled at least 10°, there is a potential problem of over-angling the joint while making sharp turns.
4. Solutions: To ensure the joint is not damaged, check the following:
 - Check the drawbar length to ensure that it is at the proper length for the RPM speed of the mower.
 - Move the tractor rear tires wider apart to limit the tractor turning radius.
 - Position the mower at multiple angles and perform the above procedure. Determine the sharpest turning radius that maintains a safe operating angle and note this position to the operator.

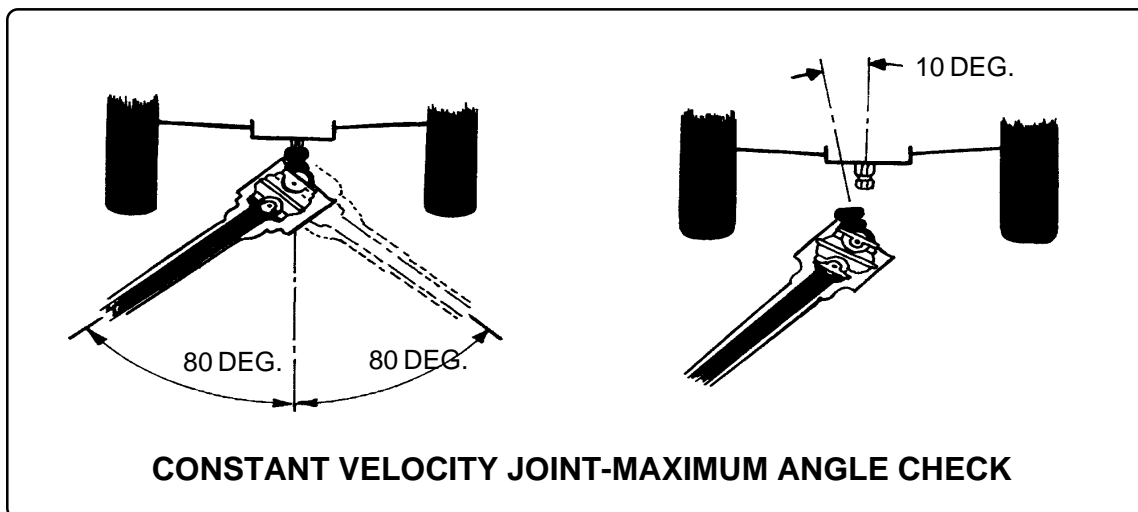

DANGER!



Do not turn so sharp or lift mower so high to produce a severe "knocking" of the Driveline which will cause accelerated wear and breakage of drive train components and could result in possible injury from the separated Driveline sections. (SRM-4)

OPERATION

7.2 Lighting Kit Relocated

Once the drivelines have been attached, the operator needs to move the flex arm light kit to the mower. The lights are located on the right side of the flex arm and need to be moved to the right rear axle of the mower.

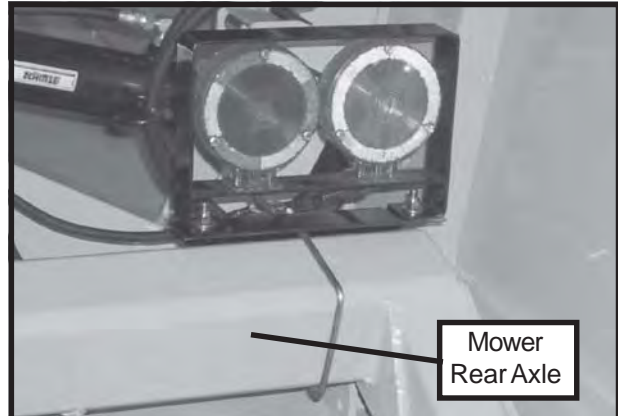
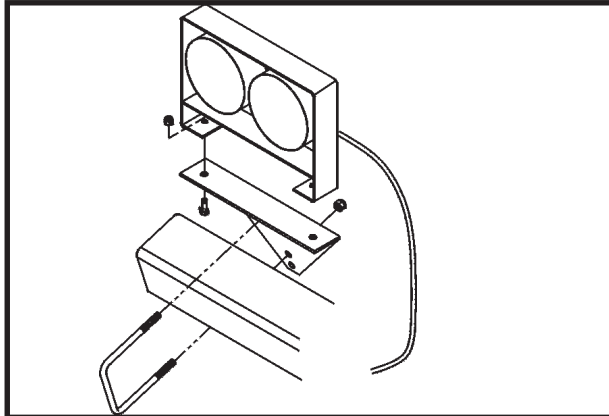

8. PRE-OPERATION INSPECTION AND SERVICE

Before each use, a pre-operation inspection and service of the mower and tractor must be performed. This includes routine maintenance and scheduled lubrication, inspecting that all safety devices are equipped and functional, and performing needed repairs. Do not operate the mower and tractor if the pre-operation inspection reveals any condition affecting safe operation. Perform repairs and replacement of damaged and missing parts as soon as noticed. By performing a thorough pre-operation inspection and service, valuable down time and repair cost can be avoided.

OPERATION

DANGER!



Always disconnect the main PTO Driveline from the Tractor before performing service on the Mower. Never work on the Mower with the Tractor PTO driveline connected and running. Blades or Drivelines could turn without warning and cause immediate entanglement, injury or death. (SRM-3)

DANGER!



DO NOT allow any person under a folded wing unless wing is securely locked up or supported. DO NOT approach the Implement unless the Tractor is turned off and all motion has ceased. Never work under the frame work, or any lifted component unless the implement is securely supported or blocked up. A sudden or inadvertent fall by any of these components could cause serious injury or even death. (STI-3)



WARNING!



Periodically inspect all moving parts for wear and replace when necessary with authorized service parts. Look for loose fasteners, worn or broken parts, and leaking or loose fittings. Make sure all pins have cotter pins and washers. Serious injury may occur from not maintaining this Implement in good working order. (SG-21)



OPERATION

8.1 Tractor Pre-Operation Inspection/Service

Refer to the tractor operator's manual to ensure a complete pre-operation inspection and scheduled service is performed according to manufacturer recommendations. The following is a partial list of items requiring inspection:

- Tire condition/air pressure
- Wheel lug bolts
- Steering linkage
- PTO shield
- SMV sign is clean and visible
- Tractor's lights are clean and functional
- Tractor Seat belt is in good condition
- Tractor cab or ROPS is in good condition
- ROPS is in the raised position
- No tractor oil leaks
- Radiator free of debris
- Engine oil level and condition
- Engine coolant level and condition
- Power brake fluid level
- Power steering fluid level
- Fuel condition and level
- Sufficient lubrication at all lube points
- Air filter condition



8.2 Mower Pre-Operation Inspection/Service

Before each mower use, a complete inspection and service is required to ensure the mower is in a good and safe working condition. Damaged and/or broken parts should be repaired and/or replaced immediately. To ensure the mower is ready for operation, conduct the following.

DANGER!



All Safety Shields, Guards and Safety devices including (but not limited to) - the Deflectors, Chain Guards, Steel Guards, Gearbox Shields, PTO integral shields, and the Retractable Door Shields should be used and maintained in good working condition. All safety devices should be inspected carefully at least daily for missing or broken components. Missing, broken, or worn items must be replaced at once to reduce the possibility of injury or death from thrown objects, entanglement, or blade contact. (SGM-3)

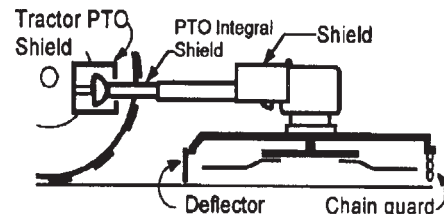

DANGER!



Replace bent or broken blades with new blades. NEVER ATTEMPT TO STRAIGHTEN OR WELD ON BLADES SINCE THIS WILL LIKELY CRACK OR OTHERWISE DAMAGE THE BLADE WITH SUBSEQUENT FAILURE AND POSSIBLE SERIOUS INJURY FROM THROWN BLADES. (SGM-10)

OPERATION

- Ensure that the Manual Canister is secured to the mower with the Operator's Manual inside.
- Ensure all decals are in place and legible. Replace missing, worn, and unlegible decals.

NOTE: The mower Operator's Manual and affixed Decals contain important instructions on the safe and proper use of the mower. Maintain these important safety features on the mower in good condition to ensure the information is available to the operator at all times.



- Ensure the mower hitch is securely attached to the tractor drawbar with a proper size bolt and secured nut.
- Ensure that a properly rated safety tow chain is equipped securing the mower to the tractor.
- Check that the main driveline is securely attached to the tractor and the locking collar is seated in the groove of the PTO shaft.
- Ensure the divider drivelines are secure at both ends



- Ensure chain guards are in position and not damaged. Replace worn, broken, and missing sections immediately.
- Ensure the driveline integral shields are in good condition and rotate freely.
- Inspect that all bolts and screws are in position and are properly torqued.



- Ensure the tractor PTO master shield is in place, lowered and in good condition.
- Ensure each mower slip clutch shield is secured in place and in good condition.
- Ensure the driveline slip clutches are properly adjusted and the friction plates are not frozen together. Reference the Maintenance Section for proper slip clutch maintenance.



OPERATION

- Perform scheduled lubrication as specified in the maintenance section.
- Inspect each gearbox oil level and replenish if needed. A low oil level is a warning sign that the gearbox may be cracked or its seal is damaged and needs to be replaced.
- Ensure all gearbox vents are in place and free from clogs.



- Ensure each hydraulic cylinder is installed and retained correctly. Ensure the proper size pins are used to retain the cylinders in place and are secured with pins.
- Check for hydraulic oil leaks on the cylinders, along the hydraulic lines, and at tractor hydraulic ports.

IMPORTANT: DO NOT use your hands to check for oil leaks. Use a piece of heavy paper or cardboard to check for hydraulic oil leaks.



- Ensure that the mower is equipped and secured with wing and center section transport lock pins.
- Check the condition of the wing hinge pins.
- Check the condition of the mower axle suspension spring.
- Inspect mower tire condition, wheel bearings, and lug nut torque.



- Inspect blades and blade bolts for looseness and excessive wear. Make sure the mower is securely blocked up before crawling beneath. Make sure that wing lock pins are installed before approaching a raised wing. Replace damaged, worn, and missing blades as complete sets to maintain rotary balance.
- Ensure carrier hub nuts are tightened with the cotter pin inserted and spread.
- Inspect the condition of the deck skid shoes and the skid shoe attaching hardware.
- Check that hitch pins are securely in place. Make sure safety chains are securely wrapped around the tractor, flex arm and mower.



OPERATION

8.3 CUTTING COMPONENT INSPECTION

Inspect blade pan and blade assembly for the following:

Damaged Pan

Cause: Blade Pan contacts an immovable object while mower was in motion.

Remedy: Inspect the area before mowing to determine where the immovable objects are located and place visible hazard markers to identify the areas. Avoid mowing in the area where immovable foreign objects exist.

Original Blade Edge

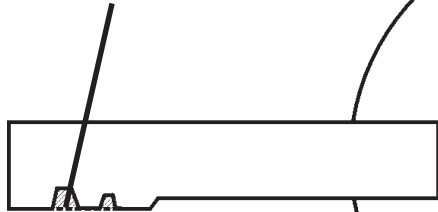

Notches and Gouges

Cause: Blade contacting foreign objects

Remedy: Inspect the area to be mowed and remove foreign objects that could cause damage to the blades

Original Blade Edge



Excessive Blade Wear

Cause: Mower height set too low.
Blade used past intended life.

Remedy: Replace Blades more often.
Adjust mower height for mowing conditions to eliminate blade-to-ground contact.

OPERATION

DANGER!



Inspect the Blades daily for abnormal wear. **REPLACE BOTH BLADES** on that carrier **IMMEDIATELY** if either blade has:

- Become bent or deformed from it's original shape, or
- Any cracks are visible, or
- Deep gouges in the blades surface are present, or
- Gouges or chipped areas in the cutting edge are larger than 1/2", or
- The material on the leading edge has been worn away by more than 1/2".

Failure to replace abnormally worn blades may lead to catastrophic failure of the blade and ejection of the broken part with tremendous force which may cause serious bodily injury or death!

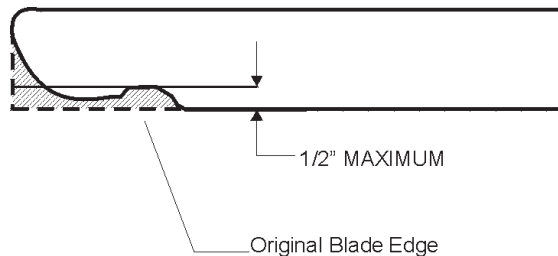

NOTE: Replace Blades in pairs after no more than 1/2" wear

OPERATION

9. DRIVING THE TRACTOR AND MOWER

Safe tractor transport requires the operator possess a thorough knowledge of the model being operated and precautions to take while driving with an attached implement. Ensure the tractor has the capacity to handle the weight of the mower and the tractor operating controls are set for safe transport. To ensure safety while driving the tractor with an attached mower, review the following.

WARNING!



Transport only at safe speeds. Serious accidents and injuries can result from operating equipment at unsafe speeds. Understand the Tractor and Mower and how it handles before transporting on streets and highways. Make sure the Tractor steering and brakes are in good condition and operate properly. Before transporting the Tractor and Mower, determine the safe transport speeds for you and the equipment. Make sure you abide by the following rules:

1. Test the Tractor at a slow speed and increase the speed slowly. Apply the Brakes smoothly to determine the stopping characteristics of the Tractor and Mower. As you increase the speed of the Tractor the stopping distance increases. Determine the maximum safe transport speed for you and this Equipment.
2. Test the equipment at a slow speed in turns. Increase the speed through the turn only after you determine that it is safe to operate at a higher speed. Use extreme care and reduce your speed when turning sharply to prevent the Tractor and Mower from turning over. Determine the maximum safe turning speed for you and this equipment before operating on roads or uneven ground.
3. Only transport the Tractor and Mower at the speeds that you have determined are safe and which allow proper control of the equipment.

Be aware of the operating conditions. Do not operate the Tractor with weak or faulty brakes. When operating down a hill or on wet or rain slick roads, the braking distance increases, use extreme care and reduce your speed in these conditions. When operating in traffic, always use the Tractor's flashing warning lights and reduce your speed. Be aware of traffic around you and watch out for the other guy. (SG-19)

DANGER!



This Implement is wider than the Tractor. Be careful when operating or transporting this equipment to prevent the Implement from running into or striking sign posts, guard rails, concrete abutments or other solid objects. Such an impact could cause the Implement and Tractor to pivot violently resulting in loss of steering control, serious injury, or even death. Never allow the Implement to contact obstacles. (S3PT-12)

OPERATION

9.1 Starting the Tractor

The procedure to start the tractor is model specific. Refer to the tractor operator's manual for starting procedures for your particular tractor. Consult an authorized dealer if the starting procedure is unclear. Ensure the 3-point control lever is in the lowered position and the PTO is disengaged before starting the tractor.



9.2 Brake and Differential Lock Setting

Make sure the tractor brakes are in good operating condition. Tractor brakes can be set to operate independently allowing single rear wheel braking action or locked together to provide simultaneous rear wheel braking. FOR MOST DRIVING AND MOWING CONDITIONS, THE BRAKE PEDALS SHOULD BE LOCKED TOGETHER TO PROVIDE THE MOST EFFECTIVE BRAKING ACTION.

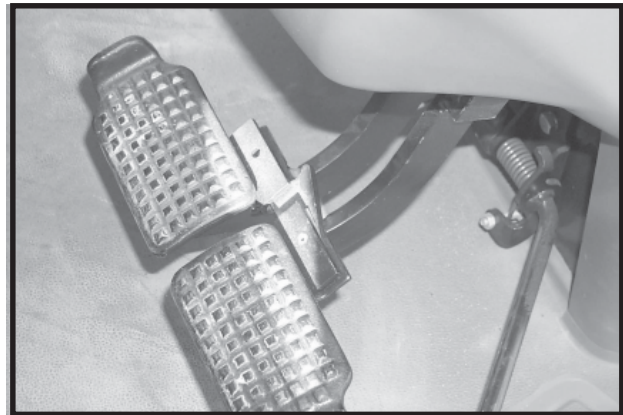

WARNING!



Be aware of the operating conditions. Do not operate the Tractor with weak or faulty brakes. When operating down a hill or on wet or rain slick roads, the braking distance increases; use extreme care and reduce your speed in these conditions. When operating in traffic, always use the Tractor's flashing warning lights and reduce your speed. Be aware of traffic around you and watch out for the other guy.

Always disengage the tractor differential lock when turning. When engaged the differential lock will prevent or limit the tractor from turning. During normal mowing conditions, locking the differential provides no benefit and should not be used.

9.3 Operating the Mower Wings

Wings are positioned with hydraulic cylinders. Ensure the hydraulic cylinders and lines are filled with oil by holding the valve control levers in the raised position until the cylinders fully retract (wings) and extend (center). Only operate the mower with both wings fully lowered, NEVER operate the mower with a raised wing. Wait until the blades are at a complete stop before raising wings.

OPERATION

Transport Position

To raise mower wings, drive the unit to a level area and retract the wing hydraulic cylinders. DO NOT raise wings with the mower positioned on an embankment

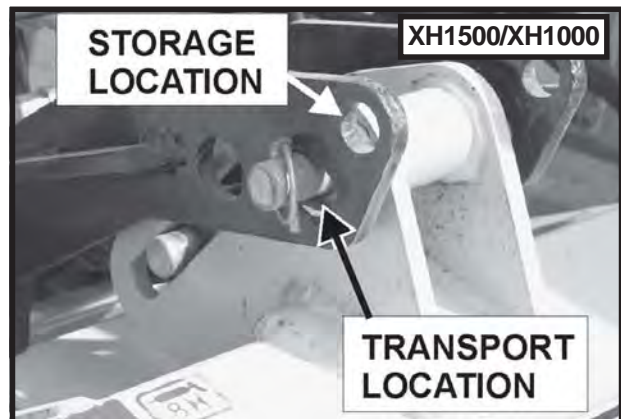
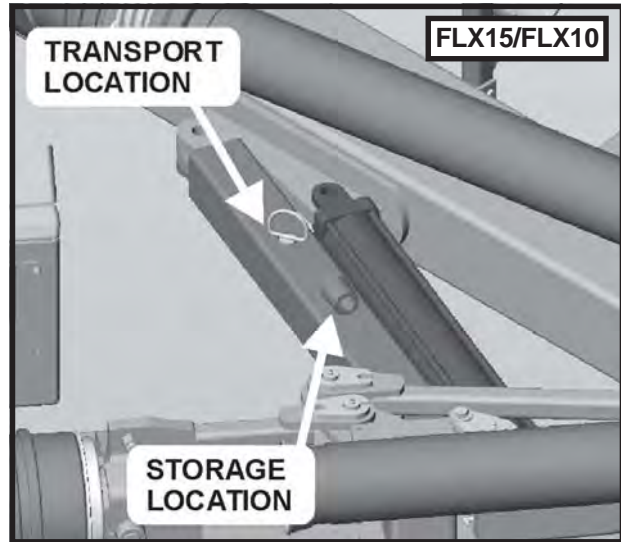
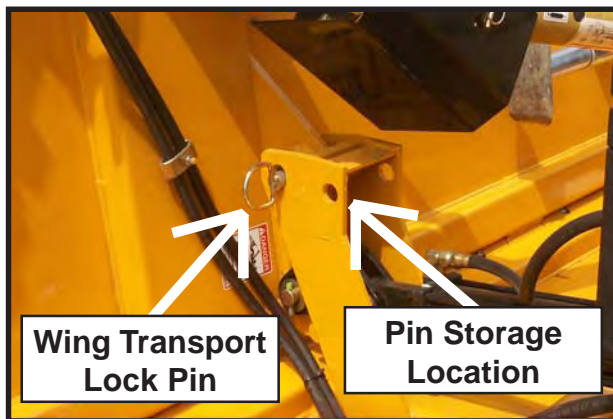
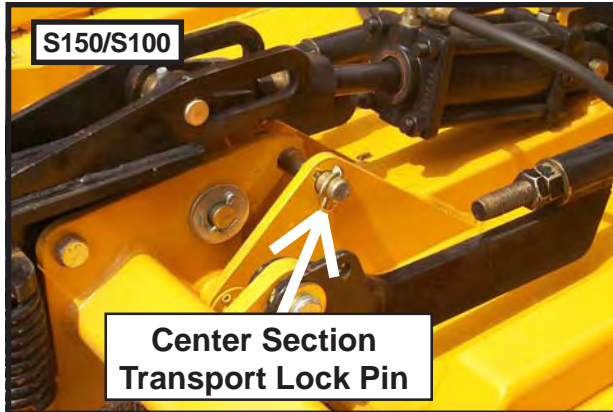

DANGER!



When the Wings are folded for transport, the center of gravity is raised and the possibility of overturn is increased. Drive slowly and use extreme caution when turning on hillsides. Overturning the Implement could cause the Implement to overturn the Tractor and vice versa resulting in serious injury or even death. Never fold wings on a hillside...the Implement may overturn. (STI-2)

Operating Position

To lower the wings, remove the transport lock pins and secure pins at storage location. DO NOT drive out transport pins that have tension on them. After removing pins, extend wing hydraulic cylinders and fully lower wings.

Wing hydraulic control valves should be set in the float detent during operation to allow the mower to follow the contour of uneven terrain and to prevent the wings from creeping up. When extending a wing over a ditch for mowing, place the control valve lever detents in the center position for greater stability.

WARNING!



Use extreme care when lowering or unfolding the implement's wings. Make sure no bystanders are close by or underneath the wings. Allow ample clearance around the implement when folding or unfolding the wings. Use extreme caution around buildings or overhead power lines. (S3PT-5)

OPERATION

9.4 Driving the Tractor, Flex Arm, and Mower

Start off driving at a slow speed and gradually increase your speed while maintaining complete control of the tractor, flex arm, and mower. Moving slowly at first will also prevent the tractor from rearing up and loss of steering control. The tractor should never be operated at speeds that cannot be safely handled or which will prevent the operator from stopping quickly during an emergency. If the power steering or engine ceases operating, stop the tractor immediately as the tractor will be difficult to control.

WARNING!



Allow sufficient clearance for the Implement to swing outward while turning. Implements carried behind the Tractor will swing outside the tire path when making turns. Contacting a solid object while turning will cause equipment damage and possible injury. (S3PT-20)

Perform turns with the tractor, flex arm and mower at slow speeds to determine how the tractor with an attached flex arm and mower handles a turn. When operating the flex arm and mower the overall working length of the unit is increased. Allow additional clearance for the flex arm and mower when turning, especially if the wings are lowered and the flex arm is extended. The mower extends to the right 3' from the FLX15 and 16" from the FLX10. Extra precaution should be taken to avoid hitting parked vehicles, sign, road structures, bystanders, and animals due to the overall length and width of the implements.



To avoid overturns, drive the tractor with care and at safe speeds, especially when operating over rough ground, crossing ditches or slopes, and turning corners. Rear tractor tire spacing should be increased when working on inclines or rough ground to reduce the possibility of tipping. Utilizing the flex arm will increase safety during operation. The tractor does not have to ride on the ditch slopes there by reducing the possibilities of a rollover.



Use extreme caution when operating on steep slopes. Keep the tractor in a low gear when going downhill. DO NOT coast or free-wheel downhill.

Practice steering and maneuvering the tractor, Flex Arm and mower in an open field or parking lot before operating the mower. Use extreme care when backing the equipment. The mower will not react to backing in the same manner as it does when the mower is connected directly to the tractor. Practice backing until you can safely control the direction and movements of the Flex Arm and mower. Back up at a slow speeds to ensure you maintain control and direction of the mower. Use care to make sure the mower is not backed in to a parked vehicle, sign, road structures, bystanders, or animals. If you do not feel that you can safely operate and back the equipment combination than obtain further training before operating this Flex Arm and mower.

OPERATION

9.5 Crossing Ditches and Steep Inclines

When crossing ditches with steep banks or going up sharp inclines, it is possible that the main driveline inner profile will penetrate into the outer housing to its maximum depth until the assembly becomes solid (driveline is at its extreme shortest length). This type of abusive operation can cause serious damage to the tractor and mower drive by pushing the PTO into the tractor and through the support bearings or downward onto the PTO shaft, breaking it off.

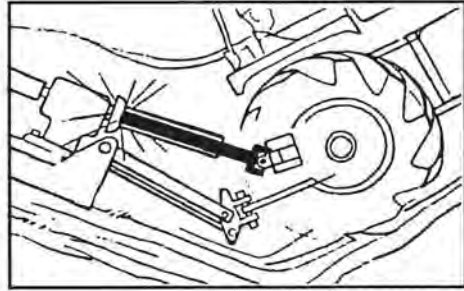

WARNING!



Damage resulting from over-collapse of the driveline's inner profile and its outer housing may allow the driveline to come loose from the Tractor which could cause bodily injury to the operator or bystanders and/or extensive damage to the Tractor or Implement

When confronted with an incline or ditch, do not approach from an angle which is perpendicular or straight on as damage to over collapse of the driveline may occur.

When crossing such terrain, the wings should be fully lowered for a lower center of gravity and added stability.

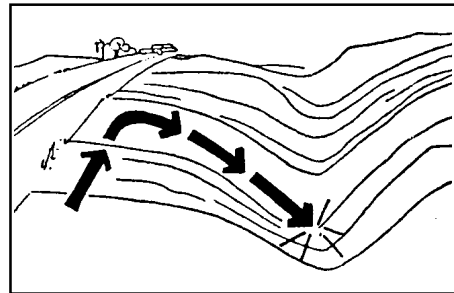

INCORRECT: DO NOT approach ditch straight on.

Inclines and ditches should be approached along a line which is at an angle as shown. This type of path will reduce the possibility of over-collapse of the driveline and resulting damage. If the gradient is so steep that such an approach increases the possibility of a tractor roll-over, select an alternate crossing path.

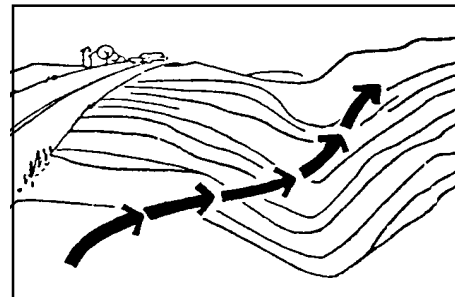

CORRECT: Approach ditch at an angle

When operating the tractor and mower across slopes and inclines, through ditches, and other uneven terrain conditions, it is important to maintain sufficient deck to ground clearance. Blade contact with the ground may cause soil, rocks and other debris to be thrown out from under the mower resulting in possible injury and/or property damage. Ground contact also produces a severe shock load on the mower drive and to the mower blades resulting in possible damage and premature wear.

OPERATION

10. OPERATING THE TRACTOR, FLEX ARM, AND MOWER

THE OPERATOR MUST COMPLETELY UNDERSTAND HOW TO OPERATE THE TRACTOR, FLEX ARM, AND MOWER AND ALL CONTROLS BEFORE ATTEMPTING TO MOW. The operator must read and understand the Safety and Operation Sections of the flex arm, mower and tractor operator's manuals. These manuals must be read and explained to any operator who cannot read. Never allow someone to operate the mower and tractor without complete operating instructions.

Before starting any mowing operation, the operator must become familiar with the area to be mowed and any obstacles and hazards contained within to ensure safety to the operator, bystanders, and equipment. Special attention should be paid to foreign debris, rough terrain, steep slopes, and passersby and animals in the area.

DANGER!



Extreme care should be taken when operating near loose objects such as gravel, rocks, wire, and other debris. Inspect the area before mowing. Foreign objects should be removed from the site to prevent machine damage and/or bodily injury or even death. Any objects that cannot be removed must be clearly marked and carefully avoided by the operator. Stop mowing immediately if blades strike a foreign object. Repair all damage and make certain the blade carrier is balanced before resuming mowing. (SGM-5)



DANGER!



Many varied objects, such as wire, cable, rope, or chains, can become entangled in the operating parts of the Mower head. These items could then swing outside the housing at greater velocities than the blades. Such a situation is extremely hazardous and could result in serious injury or even death. Inspect the cutting area for such objects before mowing. Remove any like object from the site. Never allow the cutting blades to contact such items. (SGM-6)

OPERATION

10.1 Foreign Debris Hazards

Before mowing, inspect the area to make sure there are no foreign objects that the mower blades could hit or become entangled with. Remove all foreign objects and debris. If objects are too big to remove, mark them clearly and be sure to prevent the mower blades from contacting them.



OPERATION

If you hit a solid object or foreign debris, stop the flex arm, mower, and tractor at once. Immediately idle the engine speed and disengage the PTO. Wait for all mower rotating motion to stop, then raise the mower and move the tractor and implements off the object. Inspect the area and remove, or mark the location of the debris. Inspect the condition of the mower and make any needed repairs immediately. Make sure the blades are not damaged and the carrier is balanced before resuming operation.

Always wear your seat belt securely fastened and only operate the tractor, flex arm and mower with the ROPS in the raised position. If the tractor, flex arm, or mower hits a tree stump, rock, or bump, a sudden movement could throw you off of the seat and under the tractor, flex arm, and mower. The seat belt is your best protection from falling off the tractor and the ROPS provides protection from being crushed during a tractor roll-over.

10.2 Bystander/Passersby Precautions

If a bystander comes within 100 yards of the tractor while the mower is being operated, stop the tractor at once, idle the engine and disengage the PTO. Do not engage the PTO again until all bystanders are well past the 100 yard distance.

DANGER!



Rotary Mowers are capable under adverse conditions of throwing objects for great distances (100 yards or more) and causing serious injury or death. Follow safety messages carefully.



STOP MOWING IF PASSERSBY ARE WITHIN 100 YARDS UNLESS:

- Front and Rear Deflectors, Chain Guards, or Bands are installed and in good, workable condition;
- Mower sections or Wings are running close to and parallel to the ground without exposed Blades;
- Passersby are outside the existing thrown-object zone;
- All areas have been thoroughly inspected and all foreign material such as rocks, cans, glass, and general debris has been removed.

NOTE: Where there are grass and weeds high enough to hide debris that could be struck by the blades, the area should be: inspected and large debris removed, mowed at an intermediate height, inspected closely with any remaining debris being removed, and mowed again at the desired final height. (This will also reduce power required to mow, reduce wear and tear on the Mower drivetrain, spread cut material better, eliminate streaking, and make the final cut more uniform.) (SRM-1)

OPERATION

10.3 Engaging the Power Take Off (PTO)

Before engaging the PTO, make certain that the area is clear of bystanders and passersby. The mower wings must be completely lowered and the deck positioned at a safe mowing height. NEVER engage the PTO with the mower wings in the raised position.

Set the tractor engine speed at approximately 1,000 RPM before engaging the PTO. Shift the PTO control to the on position, and slowly increase the engine speed until the PTO is operating at the rated speed. If you hear unusual noises or see or feel abnormal vibrations, disengage the PTO immediately. Inspect the mower and Flex-Arm to determine the cause of the noise or vibration and repair the abnormality.

DANGER!



Do not let the Blades turn when the Mower deck is raised for any reason, including clearance or for turning. Raising the Mower deck exposes the cutting blades which creates a potentially serious hazard and could cause serious injury or even death from objects thrown from the blades. (SRM-7)

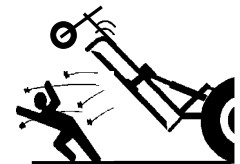

DANGER!



Do not put hands or feet under Mower decks. Blade contact can result in serious injury or even death. (SGM-9)



10.4 PTO RPM and Ground Speed

Ground speed for mowing will depend upon the height, type, and density of vegetation to be cut. Recommended speed for efficient mower performance is between 2 and 5 mph. Operate the mower at its full rated PTO speed to maintain blade speed for a clean cut. Refer to the tractor operator's manual or the tractor instrument panel for the engine speed and gear to provide the required PTO and desired ground speed. Make sure that the mower is operating at its full rated speed before entering the vegetation to be cut. If it becomes necessary to temporarily regulate engine speed, increase or decrease the throttle gradually.

Ground speed is achieved by transmission gear selection and not by the engine operating speed. The operator may be required to experiment with several gear range combinations to determine the best gear and range which provides the most ideal performance from the mower and most efficient tractor operation. As the severity of cutting conditions increase, the ground speed should be decreased by selecting a lower gear to maintain the proper operating PTO speed.

WARNING!



Do not exceed the rated PTO speed for the Implement. Excessive PTO speeds can cause Implement driveline or blade failures resulting in serious injury or death. (SG-26)

WARNING!



Mow at the speed that you can safely operate and control the Tractor and Mower. Safe mowing speed depends on terrain condition and grass type, density, and height of cut. Normal ground speed range is from 2 to 5 mph. Use slow mowing speeds when operating on or near steep slopes, ditches, drop-offs, overhead obstructions, power lines, or when debris and foreign objects are to be avoided. (SGM-7)

OPERATION

10.5 Operating the Flex Arm & Mower

When ready for field use, stop the cutter and pull the transport pins on the cylinder guard and the rotary cutter. Lower the wings and cutter before entering the ditch. Drive the tractor forward along the side of the road and extend the flex arm cylinder to ease the cutter into the ditch. Engage the PTO. Only operate the Flex-Arm and mower from the tractor operator's seat with the seatbelt securely fastened. The tractor must be equipped with a ROPS in the raised position or a ROPS cab.

Before engaging the PTO the operator needs to make sure that the blades are rotating in the correct direction. If they are not they need to contact their local dealer or Schulte to correct the problem. Refer to your operator's manual for proper blade rotation.

IMPORTANT: The operator should never operate the mower with the Flex Arm if the blades do not have the proper blade rotation. Serious injury or even death may occur if cutter is operated.

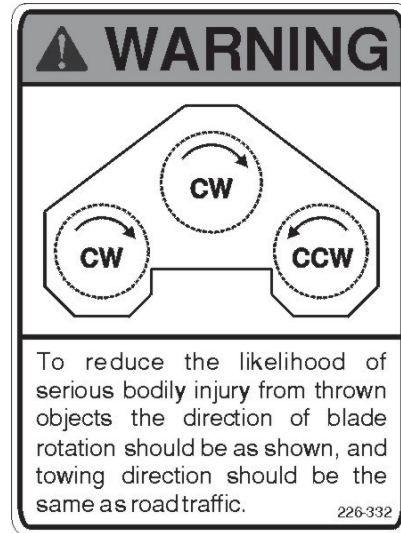

The mower is designed to cut vegetation up to 2" in diameter. Sharp blades will produce a cleaner cut and require less power. Travel at a speed that allows the mower sufficient time to cut through the vegetation and maintain the PTO operating speed to prevent overloading the Flex-Arm, mower, and tractor. When cutting on ditches use the cylinder to avoid most obstacles. The tractor may be needed to maneuver around larger obstacles. The FLX15 can swing the cutter 87" using the cylinder. The FLX10 gives 75". Choose a driving pattern that provides the maximum pass length and minimizes turning.

IMPORTANT: Do not operate the PTO with the flex arm in the transport position for extended periods of time. This may cause driveline vibration and will accelerate universal joint wear.

Under certain conditions, tractor tires may roll some grasses down preventing them from being cut at the same height as the surrounding area. However a better cut is possible with the Flex-Arm. There is only a single caster wheel in front of the cutter and it is ideally located to maximize quality of cut. Lower cutting heights in general will also increase cutting performance.

Avoid mowing in the reverse direction when possible. In situations where the mower must be backed to access areas to be cut, make sure there are no persons or other foreign debris behind the mower before mowing in reverse. The Flex-Arm attaches to the mower by means of a strut that does not allow the mower to pivot in relation to the arm. Which allows the mower to be easily backed up. However when mowing in reverse, operate the tractor, Flex-Arm, and mower at a reduced ground speed to ensure tractor, Flex-Arm, and mower control is maintained.

WARNING!



Do not mow with two machines in the same area except with Cab tractors with the windows closed. (SGM-11)

OPERATION

DANGER!



Avoid mowing in reverse direction when possible. Check to make sure there are no persons behind the Mower and use extreme care when mowing in reverse. Mow only at a slow ground speed where you can safely operate and control the Tractor and Mower. Never mow an area in the reverse direction that you have not inspected and removed debris or foreign material. (SGM-8)

Use extreme care when transporting the Flex Arm and mower on public highways and roads. The combination of Flex Arm and mower is wider than the tractor. In transport position, the mower is offset to the right of the tractor. Allow ample clearance when transporting the tractor and implements to insure that they do not contact any bystanders, signs, road structures, or other vehicles. Do not allow the trailing mower to go off the road shoulder at high speed. This may cause implements to be unsteady and may cause a roller over, serious injury or even death can occur.

WARNING!



Follow these guidelines to reduce the risk of equipment and grass fires while operating, servicing, and repairing the Mower and Tractor:

- Equip the Tractor with a fire extinguisher in an accessible location.
- Do Not operate the Mower on a Tractor with an underframe exhaust.
- Do Not smoke or have an open flame near the Mower and Tractor.
- Do Not drive into burning debris or freshly burnt areas.
- Ensure slip clutches are properly adjusted to prevent excessive slippage and plate heating.
- Never allow clippings or debris to collect near drivelines, slip clutches, and gearboxes. Periodically shut down the Tractor and Mower and clean clippings and collected debris from the mower deck.

(SGM-12)



DANGER!



Mow only in conditions where you have clear visibility in daylight or with adequate artificial lighting. Never mow in darkness or foggy conditions where you cannot clearly see at least 100 yards in front and to the sides of the Tractor and Mower. Make sure that you can clearly see and identify passersby, steep slopes, ditches, drop-offs, overhead obstructions, power lines, debris and foreign objects. If you are unable to clearly see this type of item discontinue mowing. (SGM-1)

Never raise the mower entirely while the blades are turning. If the mower must be raised higher than 12" from ground level, disengage the tractor PTO and wait for all mower rotation to come to a complete stop before proceeding to raise the mower. NEVER raise the mower wings while the blades are turning.

When turning, the angle between the tractor and mower should not be so great that a clattering of the U-joints occurs. Sharp turns can cause premature failure of the joints and place pressure on the tractor PTO shaft and could cause extensive mechanical damage to the mower and tractor.



OPERATION

WARNING!



Do not let the Blades turn when the Mower Deck is raised for any reason, including clearance or for turning. Raising the Mower deck exposes the Cutting Blades which creates a potentially serious hazard and could cause serious injury or even death from objects thrown from the Blades. (SRM-7)

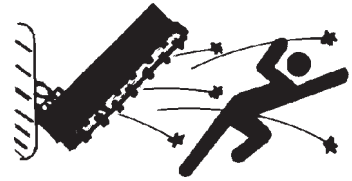

Stay alert and watch for trees, powerlines, posts, signs, and all other overhead and ground obstructions while you are mowing. Use extreme care to avoid hitting these types of obstructions.

To avoid most obstacles, use the cylinder to steer the cutter. The FLX15 can swing the cutter 87" using the cylinder. The FLX10 gives 75". The tractor may be needed to maneuver around larger obstacles.



When mowing across uneven areas such as road shoulders, ditch edges, and other uneven terrain, position mower so that one support wheel is near the highest point to prevent blades from cutting into gravel or dirt which can cause rapid blade wear and extremely severe shock loads on the drivetrain resulting in rapid wear or damage to these components. Blades contacting the ground may cause objects to be thrown out from under the mower deck. Always avoid operating the mower at a height or position which may cause the blades to contact the ground. Cutting into the berm or edge of the ditch will cause abnormal and accelerated blade wear and possible blade component failure.

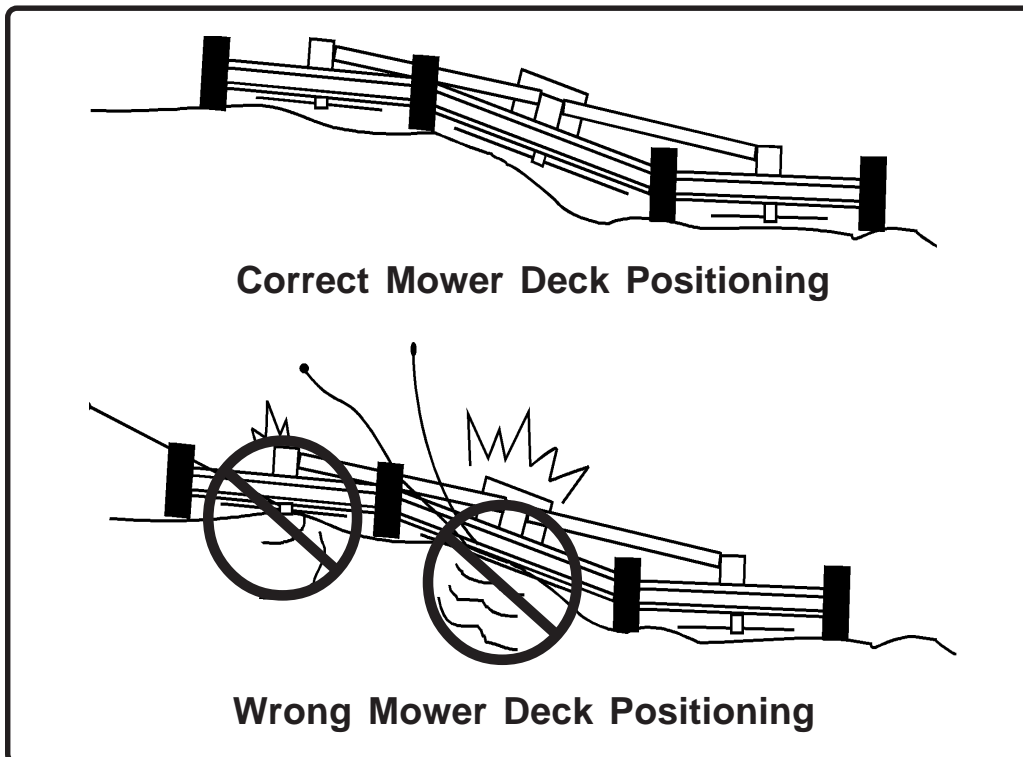

OPERATION

10.6 Shutting Down the Mower

To shut down the mower, first bring the tractor to a complete stop. Then slow down the mower by reducing the engine speed before disengaging the PTO. Wait for all rotating motion to stop before proceeding to drive or shut down the tractor.

Park the tractor on a level surface, place the transmission in park or neutral and apply the parking brake, lower the attached mower to the ground, shut down the engine, remove the key, and wait for all motion to come to a complete stop before exiting the tractor.



11. DISCONNECTING FLEX-ARM & MOWER FROM THE TRACTOR

DANGER!



Always shut the Tractor completely down, place the transmission in park, and set the parking brake before you or anyone else attempts to connect or disconnect the Implement and Tractor hitches. (S3PT-15)

WARNING!



Never unhitch without using the Tongue Jack. The Tongue is very heavy. Attempting to lift the Tongue without using the Tongue Jack could cause strains or other injury. Allowing the tongue to fall suddenly and unexpectedly could result in crushing injury. Use the Tongue Jack for lifting the Implement only. Overloading the Tongue Jack can cause failure with possible serious bodily injury or even death. (STI-4)

Before disconnecting the mower and flex arm, the PTO must be disengaged and blade rotation at a complete stop. Move the mower and flex arm to a level storage location and lower the center section and both wings to the ground. If the mower will be stored with the wings in the raised position, install both wing and center section transport pins. If the mower is not resting securely on the ground, block the mower up securely before attempting to disconnect it from the tractor.

Use extreme care to keep feet and hands out from under the mower and clear of any pinch points when disconnecting the mower from the tractor.

OPERATION

1. When disconnecting Flex arm, and mower, the tractor should be completely shut down and secured in position. Relieve hydraulic pressure by moving the control levers back and forth several times.
2. Lower the parking jack and raise the flex arm until the tongue clevis is no longer resting on the tractor drawbar and is supported solely by the jack. Make sure the jack foot is securely resting at ground level or securely supported by a block before raising the flex arm.
3. Once the flex arm tongue is being supported entirely by the jack, remove the hitch bolt, locknut, and washers.
4. Remove the flex arm driveline from the tractor PTO shaft. Place the driveline in its storage bracket to prevent it from contacting mud or dirt which can contaminate the universal joint bearings and shorten the life of the driveline.
5. Remove the hydraulic hoses from the tractor and secure to the flex-arm to prevent contact with dirt.
6. After the driveline has been removed from the tractor, place the PTO master shield back in the operating position.



12. FLEX-ARM & MOWER STORAGE

It is recommended that the mower be stored with the center section and both wings fully lowered to ground level. If the mower is stored with the wings in the raised position, select a level area and install wing transport lock pins to prevent the wings from falling BEFORE disconnecting the mower hitch and hydraulic hoses from the flex arm. Store the mower with the center section transport lock pin installed or with the mower fully lowered. Never store the mower with the center section or a raised wing supported by hydraulic pressure.

OPERATION

Properly preparing and storing the flex arm & mower at the end of the season is critical to maintaining its appearance and to help ensure years of dependable service. The following are suggested storage procedures:

1. Thoroughly clean all debris off the flex arm & mower to prevent damage from rotting grass and standing water.
2. Lubricate all flex arm & mower grease points and fill gearbox oil levels as detailed in the maintenance section.
3. Tighten all bolts and pins to the recommended torque.
4. Check the flex arm & mower for worn and damaged parts. Perform repairs and make replacements immediately so that the flex arm & mower will be ready for use at the start of the next season.
5. Store the flex arm & mower in a clean, dry place with the flex arm frame & mower housing resting securely on blocks or at ground level.
6. Keep the drivelines yokes from sitting in water, dirt and other contaminants.
7. Use spray touch-up enamel where necessary to prevent rust and maintain the appearance of the flex arm & mower.



OPERATION

DANGER!



Never allow children to play on or around the Tractor and Implement. Children can slip or fall off the Equipment and be injured or killed. Children can cause the Implement to shift or fall crushing themselves and others. (SG-25)

It is critical that driveline clutches slip when an obstacle or heavy load is encountered to avoid flex arm, mower, and tractor damage. If the flex arm & mower sit outside for an extended period of time or are exposed to rain and/or humid air, the clutch lining plates must be inspected to ensure they are not frozen together from rust or corrosion. If the flex arm & mower have been exposed to such conditions, at the start of each mowing season, and any time it is suspected that the slip clutch plates may be frozen together, readjust the slip clutch as explained in the maintenance section of the rotary cutter manual.

13. TRANSPORTING THE TRACTOR, FLEX-ARM, AND MOWER

Inherent dangers of operating the tractor, flex arm, and mower and the possibility of accidents are not left behind when you finish mowing an area. Therefore, the operator must employ good judgement and safe operation practices when transporting the tractor, flex arm, and mower between locations. By using good judgement and following safe transport procedures, the possibility of accidents while moving between locations can be substantially minimized.

DANGER!



Never allow children or other persons to ride on the Tractor or Implement. Falling off can result in serious injury or death.

(SG-10)



OPERATION

Before transporting the tractor, flexarm, and mower, idle the tractor engine, disengage the PTO. Fully retract the flex arm cylinder and ease the cutter out of the ditch as the tractor continues forward. With the implement on a level surface, and all moving parts are at a complete stop raise the cutter into transport position. Insert the transport pins in the cylinder guard on the flex arm and in wings of cutter. Also when transporting, only raise the center deck enough to clear ground obstacles to prevent tipping, especially when traveling through rough terrain.

If the tractor's hydraulic pump is not independent of the tractor PTO, or if the tractor PTO has to be run to have hydraulic power, disconnect the mower driveline from the tractor PTO output shaft. Secure the driveline to the mower deck to prevent driveline damage or loss during transport.

Before transporting the tractor on a public roadway or boarding a trailer for transport, the tractor brake pedals should be locked together. Locking the pedals ensures that both wheels brake simultaneously while stopping, especially when making an emergency stop.

Use extreme caution and avoid hard applications of the tractor brakes when towing heavy loads at road speeds. Never tow the mower at speeds greater than 20 MPH.

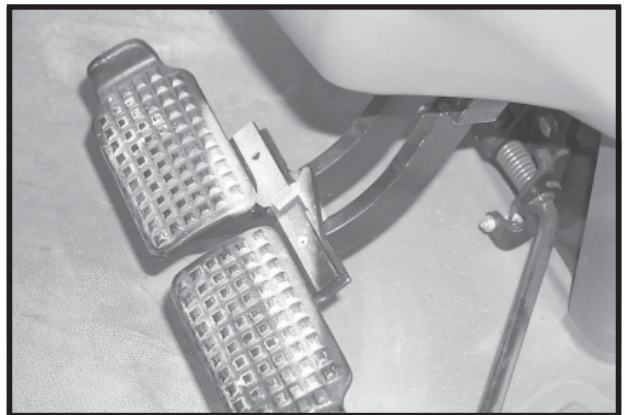

Tires and Wheels

Laminated Sectional Tires are designed for conditions where puncture proof performance is required and the mower will not be transported for long distances on roadways. Transport speed for laminated tires should not exceed 20 MPH. Excessive speed can cause damage to the machine and tire sections.

Foam Filled used Airplane Tires are ideal for conditions where a puncture proof tire is needed and the mower is frequently transported between locations.

Pneumatic Tires (used airplane or implement tires) are ideal for frequent long distance towing, however, they are not puncture proof and are not recommended for mowing brushy areas or other conditions that could damage the tires. Maximum airplane tire inflation pressure is 50 PSI, minimum inflation pressure is 40 PSI. Inflate ribbed implement tires to manufacturer rated PSI as shown on the tire sidewall. **DO NOT** over-inflate.

OPERATION

13.1 Transporting on Public Roadways

WARNING!



Only tow the Implement behind a properly sized and equipped Tractor which exceeds the weight of the Implement by at least 20%. DO NOT tow the Implement behind a truck or other type of vehicle. Never tow the Implement and another Implement connected in tandem. Never tow the Implement at speeds over 20 MPH. (STL-6)

DANGER!



Never allow children or other persons to ride on the Tractor or Implement. Falling off can result in serious injury or death. (SG-10)



WARNING!



Make certain that the “Slow Moving Vehicle” (SMV) sign is installed in such a way as to be clearly visible and legible. When transporting the Equipment use the Tractor flashing warning lights and follow all local traffic regulations. (SG-6)



Extreme caution should be used when transporting the tractor and mower on public roadways. The tractor must be equipped with all required safety warning features including a SMV emblem and flashing warning lights to alert drivers of the tractor's presence. Remember that roadways are primarily designed for automotive drivers and most drivers will not be looking out for you, therefore, you must look out for them. Check your side view mirrors frequently and remember that vehicles will approach quickly because of the tractor's slower speed. Be extremely cautious when the piece of equipment that you are towing is wider than the tractor tire width and/or extends beyond your lane of the road.

Make sure that a proper size safety tow chain is secured between the tractor, flex arm, and mower before entering a public road. Transport the flex arm with cylinder guard transport pin engaged and mower with wing and center section transport pins engaged. Do not transport the mower supported by hydraulic pressure.

Practice steering and transporting the tractor, Flex Arm, and mower in an open parking lot before transporting on public roads. Use extreme care when backing the equipment. The mower will not react to backing in the same manner as it does when the mower is connected directly to the tractor. Practice backing until you can safely control the direction and movements of the Flex Arm and mower. If you do not feel that you can safely transport or back the equipment combination do not transport the equipment on public roads and highways.

Transport at slower speeds than you would normally transport the tractor (70% of normal transport speed). Allow yourself more time to react adjust and compensate for the wider equipment. This equipment will trail behind you like two implements one behind the other. Small turns or sideways movements of the tractor can cause the trailing mower to move a greater distance to the side.

Use extreme care when transporting the Flex Arm and mower on public highways and roads. The combination of Flex Arm and mower is wider than the tractor. It is also much longer than a single implement attached to the tractor and you need to allow additional turning clearance. In transport position, the mower is offset 3' to the right of the tractor. Allow ample clearance when transporting the tractor and implements to insure that they do not contact any bystanders, signs, road structures, or other vehicles.

OPERATION

The SMV (Slow-Moving Vehicle) emblem is universal symbol used to alert drivers of the presence of equipment traveling on roadways at a slow speed. SMV signs are a triangular bright orange with reflective red trim for both easy day and night visibility. Make sure the SMV sign is clean and visible from the rear of the unit before transporting the tractor, flex arm, and mower on a public roadway. Replace the SMV emblem if faded, damaged, or no longer reflective.



Make sure that all tractor flashing warning lights, headlights, and brake/taillights are functioning properly before proceeding onto public roads. While newer model tractors have plenty of lighting to provide warning signals and operating lighting, most older models were only equipped with operating lights. Consult an authorized tractor dealer for lighting kits and modifications available to upgrade the lighting on older tractor models.

When operating on public roads, have consideration for other road users. Pull to the side of the road occasionally to allow all following traffic to pass. Reduce transport speed when traveling close to road shoulder to avoid Flex Arm and cutter from being unstable or possible roll over if mower wheels go off the shoulder. Do not exceed the legal speed limit set in your country for agricultural tractors. Always stay alert when transporting the tractor, flex arm, and mower on public roads. Use caution and reduce speed if other vehicles or pedestrians are in the area.



DANGER!



This Implement is wider than the Tractor. Be careful when operating or transporting this equipment to prevent the Implement from running into or striking sign posts, guard rails, concrete abutments or other solid objects. Such an impact could cause the Implement and Tractor to pivot violently resulting in loss of steering control, serious injury, or even death. Never allow the Implement to contact obstacles. (S3PT-12)

WARNING!



Allow sufficient clearance for the Implement to swing outward while turning. Implements carried behind the Tractor will swing outside the tire path when making turns. Contacting a solid object while turning will cause equipment damage and possible injury. (S3PT-20)

OPERATION

Reduce speed before turning or applying the brakes. Ensure that both brake pedals are locked together when operating on public roads.

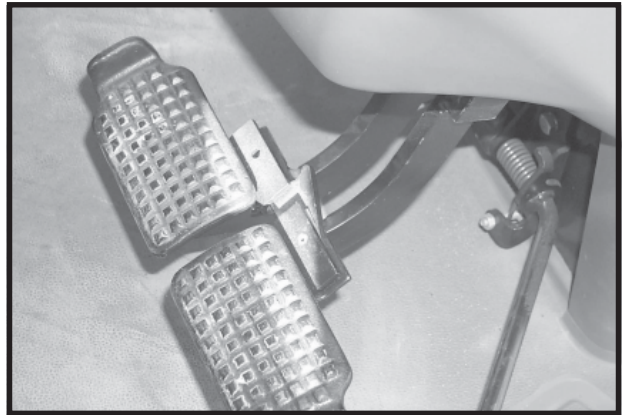

DANGER!



When the Wings are folded for transport, the center of gravity is raised and the possibility of overturn is increased. Drive slowly and use extreme caution when turning on hillsides. Overturning the Implement could cause the Implement to overturn the Tractor and vice versa resulting in serious injury or even death. Never fold wings on a hillside...the Implement may overturn. (STI-2)

In the transport position the flex arm offsets the mower as much as 3' to the right. Do not allow the trailing mower wheels to run off the edge of the road or shoulder. Sudden turns or running off the road can cause loss of stability and possible mower and tractor roll over resulting in serious bodily injury or even death.

DANGER!



Be particularly careful when transporting the Implement using the tractor. Turn curves or go up or down hills only at a low speed and at a gradual steering angle. Make certain that at least 20% of the tractor's weight is on the front wheels to maintain safe steering. Slow down on rough or uneven surfaces. (STI-1)

WARNING!



Only tow the Implement behind a properly sized and equipped Tractor which exceeds the weight of the Implement by at least 20%. DO NOT tow the Implement behind a truck or other type of vehicle. Never tow the Implement and another Implement connected in tandem. Never tow the Implement at speeds over 20 MPH. (STI-6)

WARNING!



Secure the Implement for transport before traveling on public roads. For pull-type Implements, secure the center axle using cylinder stops or transport pin and properly attach a safety chain between the Implement and Tractor. Secure wings in upright position on folding Implements using wing transport locks. (STI-7)

When transporting the implements reduce speed when going around corners. Do not make any sudden turns at a high transport speed. The tractors and implements are much longer so turning speed needs to be at a low speed, and more clearance need to be taken in account for when turning.

OPERATION

WARNING!



Transport only at safe speeds. Serious accidents and injuries can result from operating this equipment at unsafe speeds. Understand the Tractor and Implement and how it handles before transporting on streets and highways. Make sure the Tractor steering and brakes are in good condition and operate properly.

Before transporting the Tractor and Implement, determine the safe transport speeds for you and the equipment. Make sure you abide by the following rules:

1. Test the tractor at a slow speed and increase the speed slowly. Apply the Brakes smoothly to determine the stopping characteristics of the Tractor and Implement. As you increase the speed of the Tractor the stopping distance increases. Determine the maximum safe transport speed for you and this Equipment.
2. Test the equipment at a slow speed in turns. Increase the speed through the turn only after you determine that it is safe to operate at a higher speed. Use extreme care and reduce your speed when turning sharply to prevent the tractor and implement from turning over. Determine the maximum safe turning speed for you and this equipment before operating on roads or uneven ground.
3. Only transport the Tractor and Implement at the speeds that you have determined are safe and which allow you to properly control the equipment.

Be aware of the operating conditions. Do not operate the Tractor with weak or faulty brakes. When operating down a hill or on wet or rain slick roads, the braking distance increases: use extreme care and reduce your speed. When operating in traffic always use the Tractor's flashing warning lights and reduce your speed. Be aware of traffic around you and watch out for the other guy. (SG-

19)

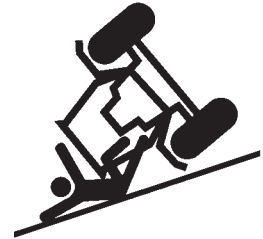

13.2 Hauling the Tractor, Flex Arm and Mower

The Flex Arm and the mower must be disconnected and separated before loading onto a trailer. Follow the instructions and safety precautions listed in this manual to disconnect and separated the mower from the Flex Arm.

Do not attempt to transport an over width load with out obtaining proper licenses and permits from your state transportation offices.

OPERATION

Before transporting a loaded tractor, flex arm, and mower, measure the height and width dimensions and gross weight of the complete loaded unit. Ensure that the load will be in compliance with the legal limits set for the areas that will be traveled through.

Use adequately sized and rated trailers and equipment to transport the tractor, flex arm, and mower. Consult an authorized dealer to determine the proper equipment required. Using adequately sized chains, heavy duty straps, cables and/or binders, securely tie down both the front and rear of the tractor utilizing the proper tie down locations as specified by the tractor manufacturer.

Arrange the chains so that when tightened, the chains are pulling downward and against themselves. Carefully tighten the securing chains or other fasteners used as much as possible using boomers or binders to apply maximum tension. Use extreme care when attaching and removing the securing devices as the extreme tension involved when released has the potential to inflict serious injury.

While hauling the tractor, flex arm, and mower, make occasional stops to check that the tractor, flex arm and mower have not moved or shifted and that the securing chains have maintained tension. If during transport a hard braking, sharp turning, or swerving action was performed, stop at the next safe location to inspect the security of the load.

OPERATION

14. TROUBLE SHOOTING GUIDE (CUTTER)

Symptom	Problem	Correction
Not cutting clean	RPM too low	Use full PTO speed
	Improper blade for direction of rotation	Install blades so rotation is correct
	Mower not level	Adjust machine
	Ground speed too fast	Reduce ground speed
Blade wears too fast	Cutting in sandy or rocky conditions	Increase cutting height
Blade bolts working loose	Bolts not tightened sufficiently	Tighten bolts to correct torque
	Bolt hole elongated or oversized	Rebuild or replace blade carrier
	Lock nut worn out	Replace lock nut
Blades cutting too high	Blades bent	Replace blades, in sets
	Blade carrier bent	Straighten or replace blade carrier
	Blade bolts loose or worn	Retighten or replace blade bolt. Up and down drift in the blade should not exceed 1 1/2"
Cutter vibrates	Broken blade	Replace blades in sets
	Blade carrier bent	Replace carrier
	New blade used with a worn blade	Replace blades in sets
	Blades "locked" together	"Unlock" blades
Accelerated wear of universal joint cross	Inadequate greasing	Carefully follow greasing instructions
Accelerated wear of universal joint sliding members	Inadequate greasing	Carefully follow greasing instructions
Torque limiter slipping excessively	Excessive load	Machine is overloaded, reduce ground speed and material intake
	Improper adjustment	Adjust springs
	Friction plates worn	Replace plates
	Oil on friction plates	Replace plates

OPERATION

TROUBLE SHOOTING GUIDE (FLX15/10)

Symptom	Problem	Correction
Excessive driveline vibration	Gearbox yokes out of phase	Phase yokes as directed in assembly section
	Tractor drawbar length incorrect	Set drawbar to length as determined by the RPM speed of the attached Rotary Cutter
Excessive castor wheel wobbling	Inadequate tension on castor wheel spring washer	Tighten jam nuts to increase the tension on the spring washer
Accelerated wear of universal joint cross	Inadequate greasing	Carefully follow greasing instructions
Accelerated wear of universal joint sliding members	Inadequate greasing	Carefully follow greasing instructions

OPERATION

MAINTENANCE SECTION

MAINTENANCE

MAINTENANCE

1. Maintenance

Nuts and Bolts

1. Check all nuts and bolts for tightness after the first 8 hours of operation, then weekly. Check the condition of cotter pins, roll pins and other fasteners weekly and replace if necessary.

2. Castor cone spring tension nuts

Two back to back cone springs are used to keep the castor assemblies tight and reduce castor whipping action. The double jam nuts that are used to lock the castor assembly in place may need to be adjusted in order to take up wear in components of the castor pivot.

The lower nut should be adjusted to the point that the cone springs are flattened, and then it should be backed off one half turn. Next, the lower nut should be held with a wrench so it does not change its position, while the upper nut is tightened down onto it.

3. Bolt Grades and Torque

When replacing damaged bolts use only plated Grade 5 bolts unless otherwise specified. Use only bolts of the correct length [Refer to the "Parts" section]. Do not replace lock nuts with nuts and lock washers. Use only original equipment lock nuts.

Recommended Torques in foot pounds for SAE Grade 5 bolts, based on dry assembly:

Bolt Size	UNC		UNF	
	Ft-lbs	Nm	Ft-lbs	Nm
1/4"	8	11	10	14
5/16"	17	23	19	26
3/8"	31	42	35	47
7/16"	49	66	55	75
1/2"	75	102	85	115
5/8"	150	203	170	230
3/4"	269	365	297	403
1"	644	873	704	954
1-1/4"	1255	1700	1380	1870

GRADE (5) Bolt Head

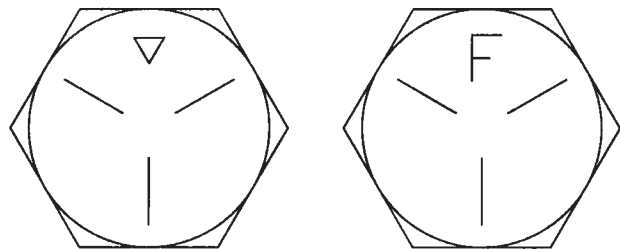

1.1 Tires

Periodically check tire pressure. The standard aircraft tire should be inflated to 40 PSI.

1.2 Steady Bearing Locking Collar

The shaft and collar must be free of paint and burrs.

Remove the tractor shaft and front bell assembly.

Insert a punch into the hole provided on the locking collar and tap the punch so that the collar turns in an anti-clockwise direction when facing the front of the collar. (The locking collar must be locked down in the same direction as the direction of shaft rotation.)

Tighten down the set screw. (We recommend using Lock-tite on the set screw threads)



MAINTENANCE

2. Wheel Hub Greasing and Installation

It is recommended that hubs are dismantled, cleaned and repacked every year. Use the diagram and following instructions for maintaining the wheel hubs. Whenever a worn or damaged seal is replaced the bearing assembly should be cleaned and repacked with a good grade of wheel grease.

WARNING!



Always read carefully and comply fully with the manufacturers instructions when handling oil, solvents, cleansers, and any other chemical agent. (SG-22)

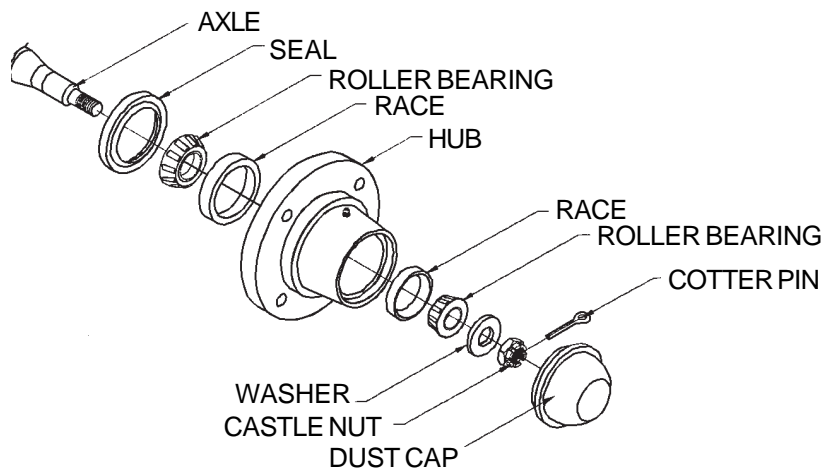

1. Using a grease packer, pack both roller bearings with a good grade of wheel grease. The bearings should be thoroughly coated with grease. Spread grease on the outside of the bearing with your gloved finger. Ensure that no dirt or filings contact the grease or the bearings.
2. Pack the inside of the hub with grease. Grease needs to cover complete surface area inside hub but does not need to fill cavity.
3. Smear grease on both races.
4. Install the large bearing into the back of the hub and rotate the bearing several times.
5. Install the dust/grease seal using the right size seal driver. Spread a film of grease on the dust seal rubber and on the axle where the seal fits.
6. Position the hub on the axle and firmly push into place then pull hub towards you about 1". Slowly rotate hub while gently pushing the hub back onto the axle.
7. Check dust seal to ensure seal rubber is positioned correctly.
8. Install the small or outer bearing.
9. Install the axle washer and castle nut on the axle.

MAINTENANCE

MAINTENANCE

2.1 Tighten Instructions for 618 Hubs

Proper Settings for the tapered roller bearings is described in the following procedure. Always use a new cotter pin when making adjustments to the hubs.

1. Tighten the castle nut to 20 foot pounds while turning hub. Then back the nut off 1/2 of a turn. Spin the hub 2 or 3 times. While slowly turning hub clockwise, hand tighten the castle nut until castle nut notch lines up with hole in axle. If notch will not line up, back off nut to next notch.
2. Put the cotter pin in the axle hole. Before bending the cotter pin spin the hub. The hub should free wheel from 1 to 2 full turns.
3. If the hub soins the right amount, finish installing the cotter pin by bending the ends.
4. Coat the inside of the dust cap with a thin coat of grease by using your gloved finger. Then install on hub using the right dust cap driver.
5. Wipe off all excess grease from hub and axle.

IMPORTANT: There should not be any drage noticed when spinning a tire installed on a hub. If the axle nut is too tight, the rollers of the wheel bearings will remove the grease from the bearing races, decreasing the life of the bearings.

2.2 Hydraulics

Periodically clean dirt and debris from the bottom side of the depth stop ring.

Inspect hydraulic hoses, fitting and cylinders for wear or leaks. Use a piece of cardboard or wood rather than hands to search for suspected leaks. Replace if necessary.

Before applying pressure to the hydraulic system, be sure all connections are tight and that the hoses are not damaged.

DANGER!



Do not operate this Equipment with hydraulic oil leaking. Oil is expensive and its presence could present a hazard. Do not check for leaks with your hand! Use a piece of heavy paper or cardboard. High-pressure oil streams from breaks in the line could penetrate the skin and cause tissue damage including gangrene. If oil does penetrate the skin, have the injury treated immediately by a physician knowledgeable and skilled in this procedure. (SG-15)



MAINTENANCE

2.3 Lubrication

Gearboxes

1. Gearboxes

Replace oil in gearboxes after the first 50 hours of operation then yearly.

Check gearbox oil level frequently. Steady loss of oil will indicate damaged seals, which should be replaced immediately to prevent ruining the gearbox.

Procedure for refilling of gearboxes:

-A dip stick is provided on the vent plug. Fill until oil shows on the dipstick. Do not screw dipstick in when checking oil level.

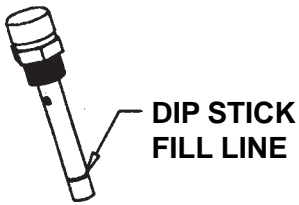

WARNING!



WHEN FILLING RIGHT ANGLE DRIVES ALLOW APPROX. 15 MIN. FOR OIL TO SETTLE INTO BOTTOM CAVITY BEFORE CHECKING DIPSTICK.

-Use of an oil/grease pump to suck oil out of the gearbox is recommended to minimize spilled oil and to provide for more complete removal of old oil.

2. Gear case oil should meet the following specifications:

-API Service Classifications GL-5

-Military Specification MIL-L-2105C

Consult the following chart for the oil viscosity recommendations:

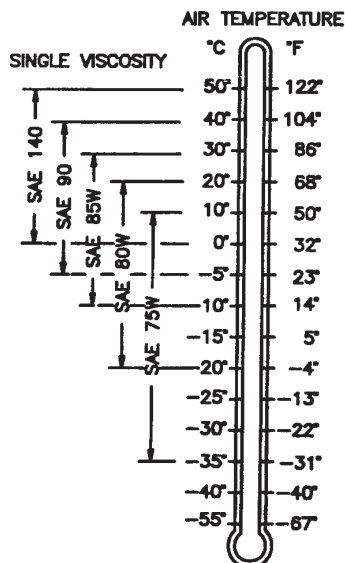

NOTE: Use SAE 80-90Gear Oil

MAINTENANCE

2.4 Universal Joint Assemblies:

-Type of Grease: A good quality NLGI #2 EP grease, lithium soap base should be used to grease the needle bearings in cross journals, shield bearings, telescoping members and CV centering mechanism. For heavy duty applications a compatible grease with 3 to 5% molybdenum disulfide additive may be used.

-Cross Journals: Every 8 hours.
Lubricate until grease purges from underneath all four needle bearing caps.

-Shield Retaining Bearings: Every 8 hours.
The shield bearings are greased by a fitting molded into the shielding bell. Three pumps are required.

IMPORTANT: Check that the driveline shielding is not damaged and rotates freely on the driveline.

-Constant Velocity Body: Every 4 hours.
The housing for the CV body serves as a reservoir for the lubrication of the centering mechanism. Approximately 30 pumps are required every 4 hours.

-Telescoping Tubes: Every 4 hours. Apply grease to the collar located at the middle of the shaft. The grease fitting on this collar will come exposed when the cutter wings are laying flat. Occasionally (monthly) pull the universal joint halves apart and apply grease to all sides of the slip shaft. At least once per year (more often in dusty or dirty conditions) the shielding should be removed and the old grease removed with a solvent. A fresh coat of grease should then be applied to the entire surface of the inner tube.

IMPORTANT

Apply grease to cross shaft in the collapsed and extended positions every 4 hours

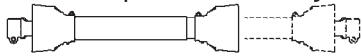

226-364

IMPORTANT: If the universal joint sliding members are allowed to dry out to the point where two halves cannot slip freely, damage to the rotary cutter or tractor may occur.

CAUTION! Always wear protective gloves when handling grease.



2.5 Frame

NLGI #2 EP molybdenum disulfide fortified grease is preferred for all sliding contact type applications such as frame pins.

Frame pivot points: Daily during the first week of usage, and every 50 hours of operation thereafter, 16 locations:

- (1) Hitch clevis, swivel
- (1) Hitch frame, main pivot
- (2) Steady bearing stand
- (1) Arm link
- (1) Gearbox mounting stand, main pivot
- (1) Gearbox mounting stand, link
- (1) Arm link
- (2) Castor frame link – FLX15 only
- (1) Arm, main pivot
- (1) Castor frame, pivot – FLX15 only
- (1) Hydraulic cylinder – rod end
- (2) Castor pivot sleeve
- (2) Hitch tongue – cross pin grease zerk is on bottom side of sleeve

FLX15/10 04/06

Maintenance Section 5-6

MAINTENANCE

Lubrication Chart



10 locations



16 locations

*Designates FLX15 only

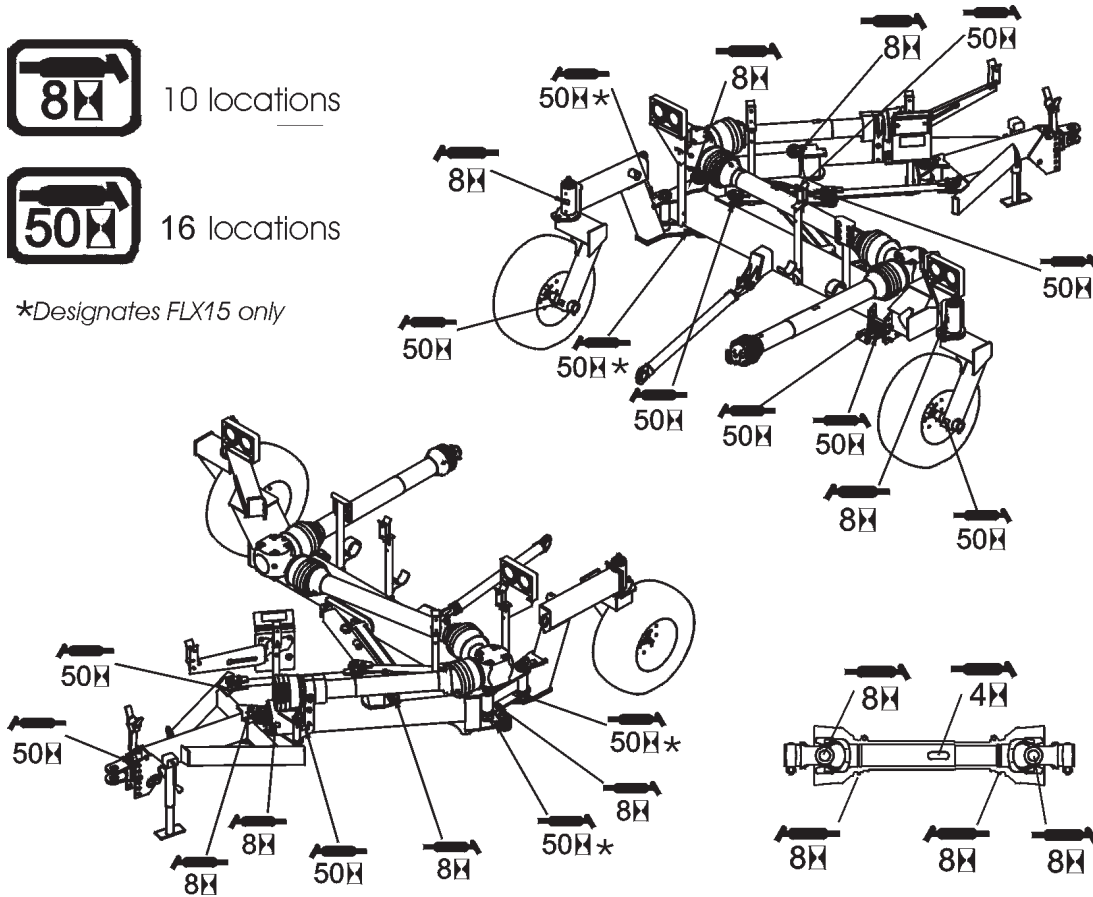

Specifications

FLX15 Hydraulic Circuit Requirements

Hoses and breakaways are provided in order to connect to a 15' rotary cutter with individual single acting wing circuits. A total of 4 hydraulic circuits are required. Two of the circuits require float positions on the control valves in order to operate the single acting wing circuits on the rotary cutter.

FLX10 Hydraulic Circuit Requirements

Hoses and breakaways are provided in order to connect to a 10' rotary cutter with single acting wing circuit. A total of 3 hydraulic circuits are required. One of the circuits requires a float position on the control valve in order to operate the single acting wing circuit of the rotary cutter.

Solenoid Valve Kit

An optional solenoid valve kit is available for the FLX15 and FLX10 to reduce the number of tractor circuits require to operate the FLX15, from 4 to 3 circuits, and the FLX10, from 3 to 2 circuits.

The kit includes additional hoses and breakaways in order to operate the wing lift cylinders in double acting mode and does not require a float position on the tractor control valves.

MAINTENANCE

RAMLOK DISASSEMBLY PROCEDURE

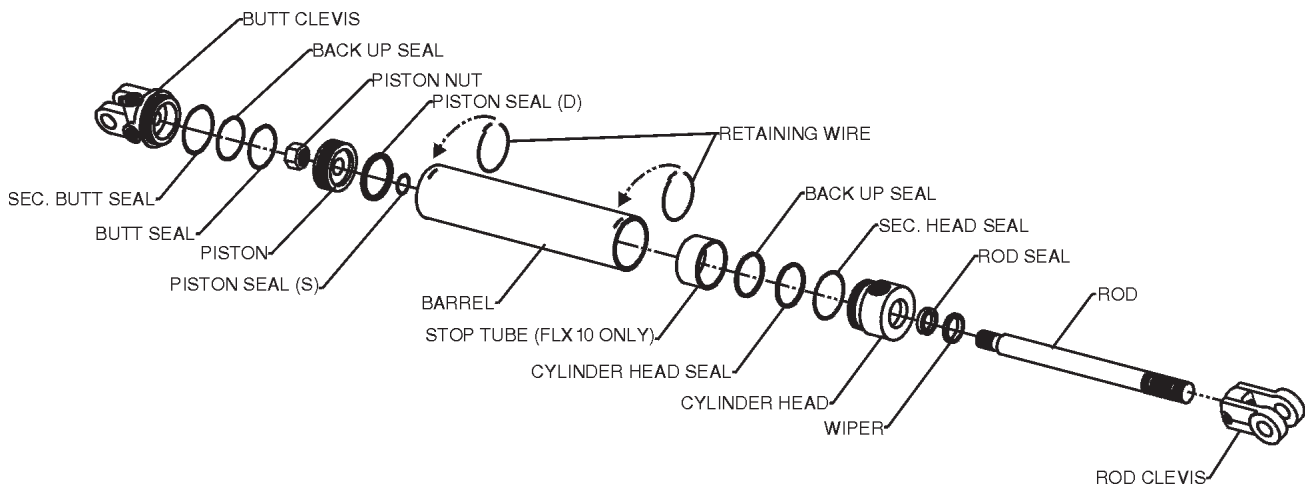

1. Replacement cylinder head and butt seals must be available before beginning disassembly as they will be damaged during the procedure. The piston seal may also be subject to damage during disassembly.
2. Secure the cylinder snugly in a vice. Do not over tighten the vice or the barrel will compress.
3. Locate the slots at either end of the barrel. The cylinder head will be removed first.
4. Using a thin blade screwdriver, insert the blade into the end of the slot near the cylinder head and pry the retaining wire up slightly.
5. With the screwdriver under the wire, rotate the cylinder head to thread the wire out. The cylinder head can be turned with a pin wrench in the holes provided, with a pipe wrench, or with a strap wrench.
6. Thread the wire completely out of the barrel. Note which hole in the cylinder head that the wire was inserted in (there are 4 holes in the cylinder head. When reinstalling the cylinder head, the wire must be inserted in the same hole and the wire must be installed in the opposite rotation from removal (ie. If the cylinder head was turned clockwise to remove the wire, it must be turned counterclockwise for installation). This will ensure correct port orientation.
7. With the cylinder head wire completely removed, disassembly can continue. Ensure that the ports at both ends of the cylinder are open to the atmosphere. Insert a long pin or a bar thru the pin hole on the shaft mount. Use this bar to fully extend the shaft. A hard pull should dislodge the cylinder head from the barrel.
8. Continue to pull on the shaft until the o-ring on the cylinder head becomes lodged in the slot in the barrel. Insert a knife in the slot and cut the o-ring and back up seal. These seals can be threaded out thru the slot in the barrel.
9. Continue to pull on the shaft. The cylinder head, piston and shaft will pull free from the barrel.

MAINTENANCE

10. If the seal at the butt end of the cylinder needs to be replaced, disassembly is the same as for the cylinder head (see steps #3, 4 and 5). Again, note the rotation used to remove the wire and use the opposite rotation for assembly. There is only one wire hole in the butt.

11. To remove the piston nut, do not clamp the shaft in a vice as it may be damaged. Locate a pin that will fit nicely thru the shaft clevis. Insert the pin vertically in a vice and tighten it securely. Insert the shaft clevis over the pin.

12. Remove the piston nut. The piston and cylinder head can now be removed.

13. Inspect all components for wear and scoring. Closely inspect the bore of the barrel for scoring or wear marks. Check the shaft closely for wear marks, scoring, pitting or rust (discoloration of nitrosteel shafts is normal). Check the bore of the cylinder head for wear marks, scoring and rust. Check the outside diameter of the piston for wear marks or scoring. Check seals for wear, nicks, tearing or other damage.

14. Replace all damaged components. It is recommended that all seals be replaced, even if there is no visible damage.

15. Assembly is the opposite of disassembly. Use a small amount of oil to lubricate all seals prior to assembly. Caution must be used to prevent seal damage.



SCHULTE INDUSTRIES LIMITED
WARRANTY POLICY for ROTARY CUTTERS and FLEX ARMS

This Warranty Policy Applies only to Schulte Manufactured Product

Affected Models include S70, S100, XH600, XH1000, S150, XH1500, FX520, FX210, V1280, and 5026, Rotary Cutters as well as FLX10 and FLX15 Flex Arms

Schulte Industries Ltd (“the manufacturer”) warrants to the original purchaser only, that in the event of any defect in material or workmanship in the Rotary Cutter or Flex Arm, the subject of this warranty (“the goods”) during the warranty period mentioned below the manufacturer will provide the coverage specified below.

This warranty is in place of any other warranty or guarantee whether implied or expressed in any conditions of purchase of the buyer, and does not extend to impose any further liability on the manufacturer than set out below.

1) WARRANTY COVERAGE

In respect of claims notified:

- A) Warranty coverage for product in **commercial** use includes parts and labor on repair for structural, component, and driveline failures during the first **six (6) months**

- B) Warranty coverage for product in **non-commercial, governmental, municipal or farm** use includes parts and labor on repair for structural, component, and driveline failures during the first **twelve (12) months**.

Additional Pro-rated Gearbox Warranty Coverage for Non-Commercial use on models XH600, XH1000, XH1500 Cutters

Extended pro-rated gearbox warranty, extending to **sixty (60) months** as noted below:

- 1st year - full warranty (parts and Labor)
- 2nd year - 75% warranty on replacement gearbox parts only.
- 3rd and 4th year – 50% warranty on replacement gearbox parts only.
- 5th year – 25% warranty on replacement gearbox parts only.

On models S70, S100, FX210, FX520, S150, 5026, V1280 Cutters, as well as FLX10 and FLX15 Flex Arms

Extended pro-rated gearbox warranty, extending to **thirty six (36) months**, as noted below:

- 1st year - full warranty (parts and Labor)
- 2nd year - 75% warranty on replacement gearbox parts only.
- 3rd year – 50% warranty on replacement gearbox parts only.

- A) Warranty coverage for product in **rental** use includes parts and labor on repair for structural, component, and driveline failures during the first **thirty (30) days**.

The buyer is responsible for any labor charges exceeding a reasonable amount as determined by the manufacturer, and for returning goods to the dealer, whether or not the claim is approved. The buyer is responsible for the transportation costs of the goods or part(s) from the dealer to the factory.

2) CONDITIONAL COVERAGE

This warranty is conditional upon:

- A) Care, Maintenance and operation in accordance with the manufacturer's specifications and recommendations (as set out, or referred to in the "manual") supplied for the goods.
- B) Filling out the manufacturer's Warranty Validation form, and returning it to the manufacturer within thirty (30) days of receipt of goods by the buyer.
- C) Filling out the manufacturer's Warranty Claim form and returning it to the manufacturer within thirty (30) days of the repair.
- D) Examination of the goods by the manufacturer or one of its agents to verify that the goods are defective in material or workmanship.

3) EXCLUSIONS

This warranty does not extend to:

- A) Damage or deterioration after delivery from the manufacturer's works not attributable to defective material or workmanship.
- B) Any goods after they have been altered or repaired other than by the manufacturer's employees or its' agents in each case authorized in writing by the manufacturer to affect that specific alteration or repair to those specific goods.
- C) Any equipment or machinery of any kind furnished by the buyer, or belonging to, or acquired from third parties at the buyer's request, or supplied, or made to the buyer's specifications.
- D) Any goods which have sustained damage or deterioration attributable to damage from foreign objects (e.g. stones, iron, material other than grass or brush), inadequate or faulty assembly, improper or inadequate maintenance, or neglect, or abuse.
- E) Normally wearing parts (e.g. blades, blade bolts, skid shoes, tires, slip clutch linings)

4) CLAIMS and CORRESPONDENCE

All notices and correspondence to the manufacturer shall be confirmed by letter addressed to:

Attention: Warranty Committee
Schulte Industries Limited
P.O. Box 70
Englefeld, Saskatchewan
S0K 1N0, Canada

