

**Tiger**<sup>TM</sup> ROTARY AND FLAIL

# Boom Mowers



## Bengal Boom Mower

22' Bengal Boom Mower with 50" Rotary head and shown with optional Perimeter Guard.

DURABILITY

INNOVATION

COMMITMENT

18'



22'



24'





**50" Rotary**



**60" Rotary**



Cuts Up to 6" brush

50" or 60" Bengal Rotary heads have the choice of Disc or Blade bar cutting systems.



Cuts Up to 5" brush

## Flail heads



63" Flail with Grass knives



50" Flail with MBG knives

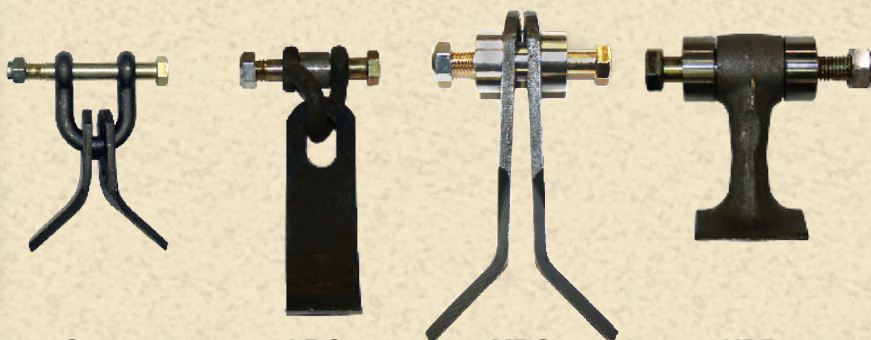

Grass  
Grass only

LBG  
Up to 2 1/2" brush

MBG  
Up to 3" brush

HDB  
Up to 4" brush



50" Flail with HDB knives



# Independent Mower Hydraulic System

Independent Mower Hydraulic System with Tandem Pump, Oil Cooler, In-Cab Temperature Gauge and Wheel Well Tank. Components shown are not the same on all tractor models. Independent Mower Hydraulic System not included on all models of tractors, check with your Tiger Dealer for your specific make and model of tractor.



**TANDEM PUMP**



**OIL COOLER**



**IN-CAB TEMP GAUGE**



**HYDRAULIC WHEEL WELL TANK**



# Modular Frame

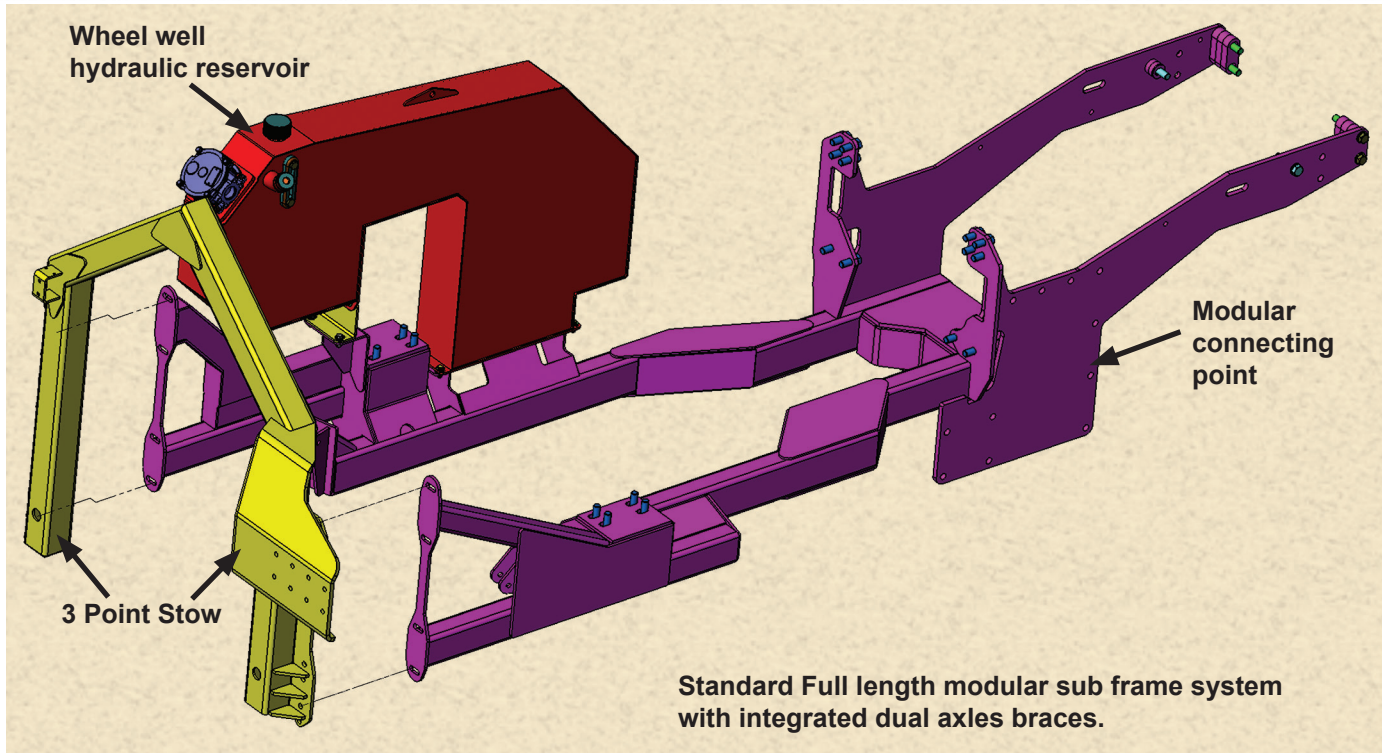

Standard Full length modular sub frame system with integrated dual axles braces.

To enhance the adaptability of our products, Tiger offers a modular mounting frame to ease mower change for your vegetation needs. This unique design offers interchangeability with our boom and side mowers. With the Tiger modular frame, changing mower types can be accomplished in approximately 8 hours. The boom mower frame should be installed at the onset to ensure the most effective framing system for future changes.

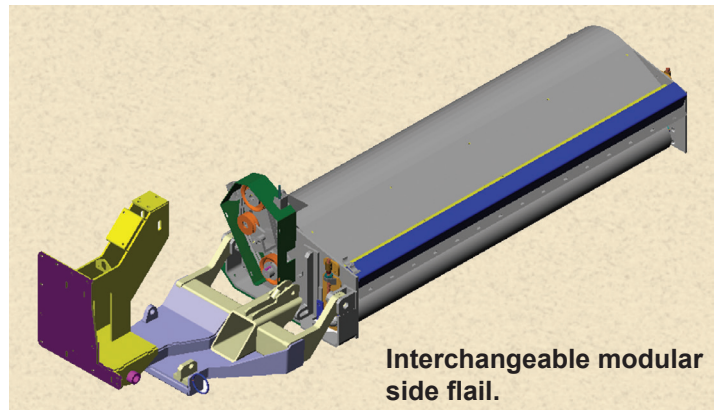

Interchangeable modular side flail.

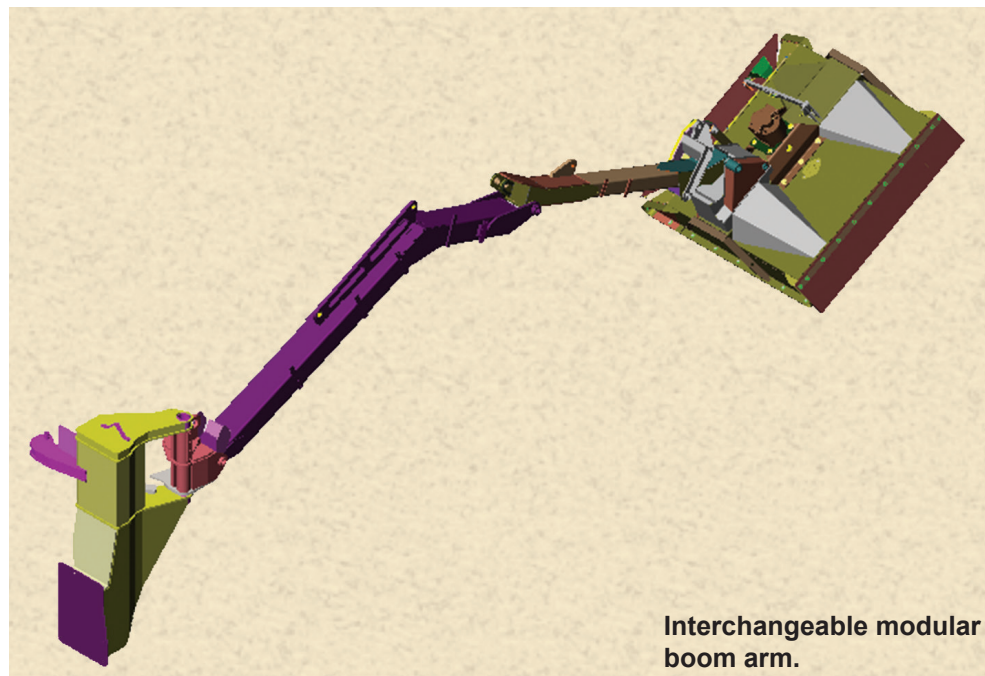

Interchangeable modular boom arm.

25'



28'



30'





# Rotary heads



## 50" Rotary



## 60" Rotary

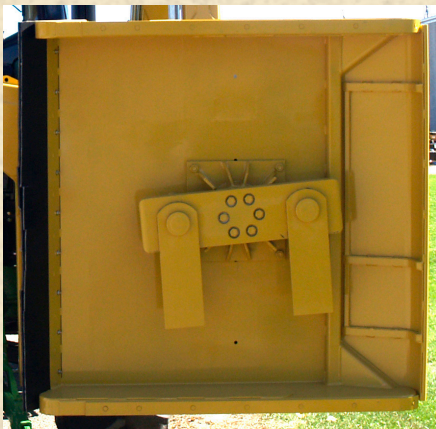

25' Saber Only  
Cuts Up to 8" brush

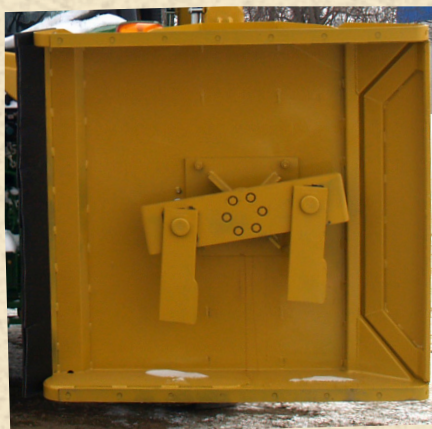

28' and 30' Saber  
Cuts Up to 6" brush



Cuts Up to 5" brush

# Flail heads



63" Flail with Grass knives  
Only available on 25' Saber



50" Direct Drive Flail with MBG knives  
Only available on 30' Saber

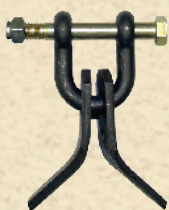

Grass  
Grass only



LBG  
Up to 2 1/2" brush

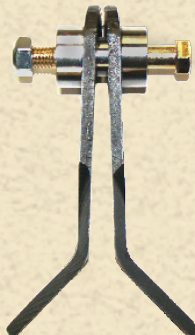

MBG  
Up to 3" brush



HDB  
Up to 4" brush



50" Flail with HDB knives



# Electronic Boom Positioning Sensor

- This optional feature can be added or retrofitted to any existing Tiger Boom Mower.
- Two sensors are located under the swivel of the boom arm.
- As the operator swings boom toward rear stow position, the sensors will identify the boom location (approx. 25" from stow position) and slow travel speed down and then stop directly above the rear stow.



## **BOOM ARM SWIVEL SLIDING OVER SENSORS**

Video of Boom Positioning Sensor is located on Tiger website  
Look under Tiger Products and then Tiger Videos





**PERIMETER GUARD**



**BOOM REST EXTENSION**



**"GROWLER" MULCHING HEAD**  
**Comes Standard with Hydraulic Head Tilt**



# Stow Systems



**3 PT OPEN STOW (30S)  
W/ DBL AXLE SUPPORT**



**BENGAL BRUTE STOW  
W/ SECONDARY BOOM  
BREAKAWAY**



**50" ROTARY SWIVEL HEAD**



**60" ROTARY SWIVEL HEAD**



**50" ROTARY SWIVEL HEAD IN STOW POSITION**



**Transport width of pictured unit is 109" (JD 6105E, BB-22)  
Width depends on make and model of tractor**



# Options



## CABLE CONTROLS

Hydraulically driven Cable Controls for Boom mower.



## ELECTRONIC JOYSTICK

Electronic over hydraulic Joystick Control.



## PUMP/GRILL GUARD

Additional protection with Pump or Grill Guard.



## AXLE STABILIZER or TIMBREN

Additional stability and control for larger booms. Tractor specific, contact your Tiger Dealer for the option that matches your model of tractor.

# Standard Features



## TRAVEL SAFETY LOCK

Controlled from operator's position.

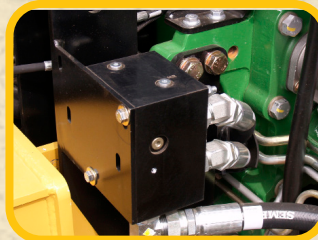

## BRAKE VALVE

Brake valve stops the cutter head in less than 7 seconds.



## NITROGEN ACCUMULATOR

Provides smooth response and reduces shock.



## SAFETY LIGHTING

Lightbar or rear signals on all boom mowers.

### Dealer Info:

**Tiger Mowers LLC**  
3301 N Louise Ave.  
Sioux Falls, SD 57107  
800-843-6849  
[www.tigermowers.com](http://www.tigermowers.com)  
An Alamo Group Company

Contact Tiger Mowers LLC for tractor compatibility requirements. Specifications are subject to change without notice. Optional equipment may be shown. One Year Warranty on all products.

Sourcewell

Awarded Contract

Contract # 070821-TGR



MADE WITH PRIDE IN THE USA